



---

## AIR CURTAINS AND AIR CURTAIN-FAN HEATER UNITS

*Air curtains ELiS and Slim*



# AIR CURTAINS AND AIR CURTAIN-FAN HEATER UNITS

## COMPARE ELiS SOLUTIONS

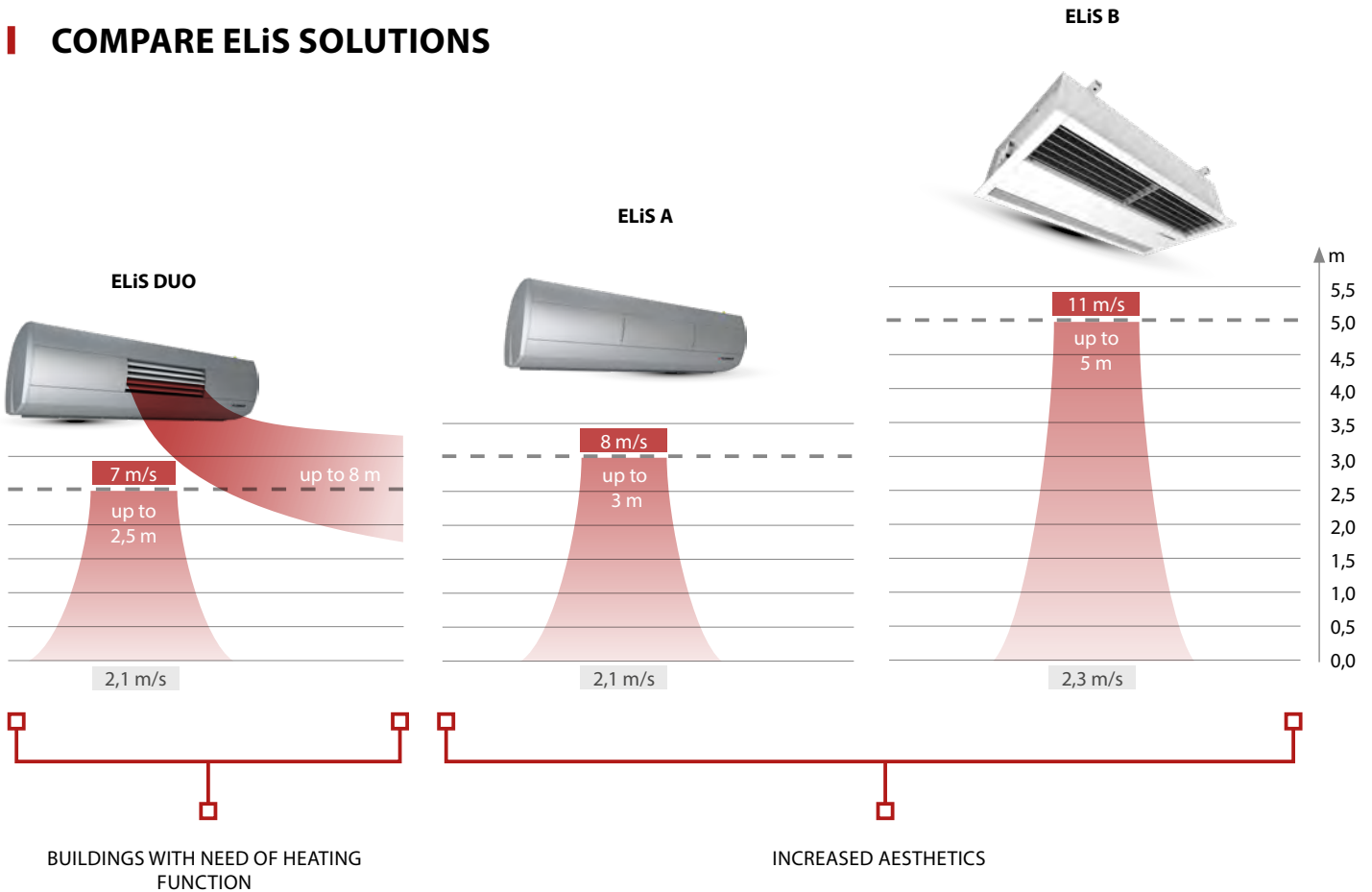

## TECHNICAL DATA

	ELiS DUO	ELiS A	ELiS B
<b>Version</b>	W/E	W/E/N	W/E/N
<b>Height of installation</b>	up to 2,5 m	up to 3 m	up to 5 m
<b>Air flow</b>	1200–3700 m <sup>3</sup> /h	850–3500 m <sup>3</sup> /h	2000–6600 m <sup>3</sup> /h
<b>Acoustic pressure level</b>	45–60 dB(A)	44–59 dB(A)	55–66 dB(A)
<b>BMS</b>	as standard	as standard	as standard

N – without heating elements

W – water heat exchanger

E – electric heaters

— – speed limit at the floor level

■ – outlet air velocity

## APPLICATION



- reception
- banquet rooms
- shops



- exhibition centers
- banks
- airports



- hotels
- offices
- shopping centers

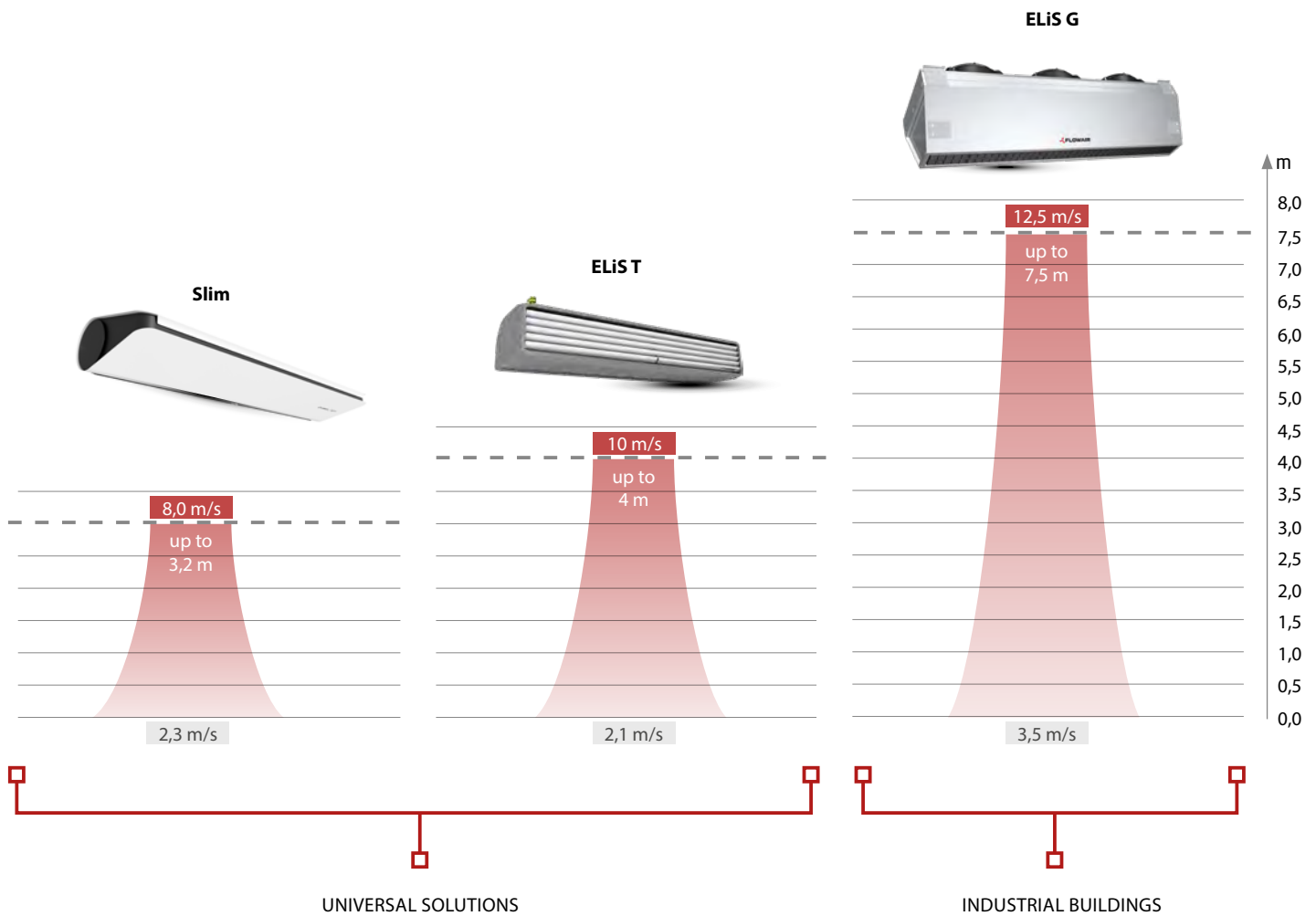

<b>Slim</b>	<b>ELiS T</b>	<b>ELiS G</b>
W/E/N	W/E/N	W/E/N
up to 3,2 m	up to 4 m	up to 7,5 m
750–3000 m <sup>3</sup> /h	1700–5300 m <sup>3</sup> /h	1100–8600 m <sup>3</sup> /h
33,5–58 dB(A)	55–65 dB(A)	44–68 dB(A)
via external DRV Slim module	via external DRV ELiS module	via external DRV ELiS module

The sound pressure level measured in a room with an average sound absorption capacity, 1500 m<sup>3</sup>; directivity factor Q = 2



- shops
- shopping centers
- petrol stations



- shopping centers
- restaurants
- train stations



- industrial halls
- logistics centers
- warehouses

---

# FLOWAIR R&D LAB

FLOWAIR - expert and manufacturer of HVAC equipment is a member of the EUROVENT Europe's Industry Association for Indoor Climate. This organisation brings together the largest companies in the industry, which jointly create new guidelines and recommendations that are eventually presented to the European Commission. The Association is looking for solutions related to energy savings inside buildings and the use of air curtains is one of recommended solutions.

The use of air curtains allows for thermal protection of the room. Curtains create an air barrier in the door opening and reduce heat losses / heat gains resulting from the inflow of cold air from outside in the winter, as well as inflow of warm air into the air-conditioned rooms during the summer. Presently, the regulations regarding energy losses when the doors are opened are not very clear.

A special project group at EUROVENT is currently developing a methodology for testing and describing air curtains in terms of their effectiveness to get a reliable comparison of their parameters. FLOWAIR - the only Polish producer participating in the project group has created a test stand to measure the effectiveness of air curtains. Based on the tests carried out and subsequent results, new tools will be created to simplify making informed investment decisions. Simply put, to help the end clients choose a proper solution.



## I ADVANTAGES OF LABORATORY TESTING FOR THE CLIENT

At FLOWAIR, we constantly undertake activities aimed at increasing the quality of our products and services. A laboratory test is yet another step on the way to continuous product improvement and greater customer satisfaction.



**Confirmed parameters**



**Reliable comparison**



**Energy -saving**



**Lower risk of investment**



---

## NEW FUTURE PROOF STANDARD

We strive for the highest quality of our products. Thanks to laboratory measurements of the effectiveness of air curtains, our customers can be sure that our devices will properly protect the door openings.



## TEST OF AIR CURTAIN EFFICIENCY IN RELATION TO TEMPERATURE DIFFERENCES

The test was carried out in the FLOWAIR R&D lab, in order to measure the effectiveness of the air barrier created by the air curtain relative to the temperature difference.

### TEST 1

Measurement of air temperature difference between the „cooling“ and „heating“ chambers upon opening the door - with curtain in Off mode. Chamber 1 simulates external conditions (air temperature is 2°C), and chamber 2 simulates conditions inside the building (air temperature is 20°C).

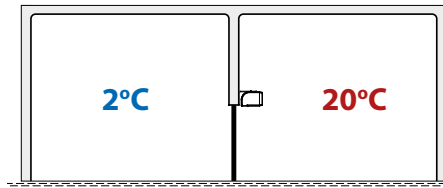

Simulation of external conditions - two closed chambers (cooling and heating).

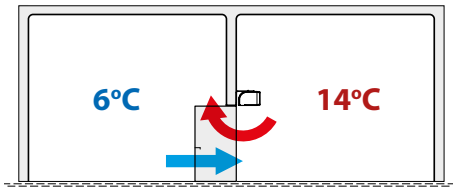

The door open for 60 seconds. Air temperature measurement with the curtain OFF.

### TEST 2

The second measurement is the air curtain effectiveness test – the air temperature difference between the „cooling“ and „heating“ chambers upon opening the door with the air curtain ON.

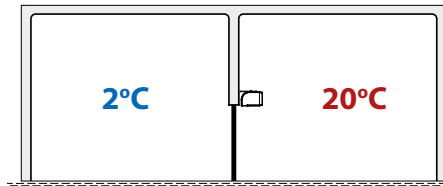

Simulation of external conditions - two closed chambers (cooling and heating).

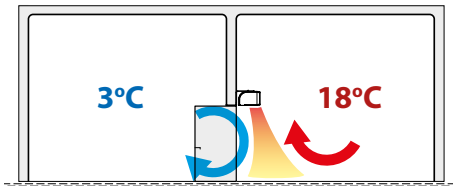

The door open for 60 seconds. Air temperature measurement with the curtain ON.

## TEST OF AIR CURTAIN EFFICIENCY IN RELATION TO AIRFLOW

Testing the effectiveness of the air curtain in relation to the airflow (wind simulation) allows you to assess the airflow of the curtain.

### TEST 1

Stabilization of the vacuum pressure (-2.5 Pa) between the chambers and measurement of exhaust fan's efficiency with the door opened.

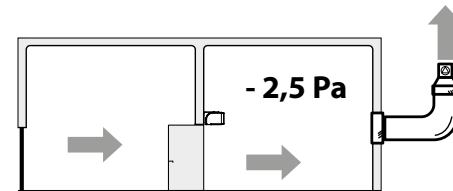

Stabilization of the vacuum pressure and efficiency of exhaust fan.

### TEST 2

Efficiency test of exhaust fan with air curtain ON.

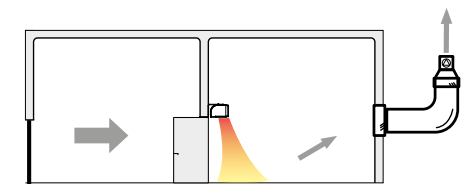

Measurement of the exhaust fan capacity with the air curtain ON.

## ISO STANDARD

The FLOWAIR door and gate curtain tests are carried out based on ISO standards, defining the aerodynamic properties of the air curtains (ISO 27327-1) and laboratory methods for testing the sound power level (ISO 27327-2). We take the requirements of the future ISO 27327-3 standard into account, specifying testing methods to determine the effectiveness of the air curtains.

# AIR CURTAIN Slim



Range<sup>(1)</sup> [m]  
**3,2**

Heating capacity<sup>(2)</sup> [kW]  
**1,2–29,3**

Weight [kg]  
**14,7–26,9**

Casing  
**Steel**

Airflow [m<sup>3</sup>/h]  
**750–3000**

2 colors as standard<sup>(3)</sup>  
**White with black elements  
and deep black**



**SPECIAL PAINTING  
ON REQUEST**

<sup>(1)</sup> according to ISO 27327-1

<sup>(2)</sup> Slim W power and temperature range specified for the parameters: fan speed III, heating medium temperature 40/30°C air temperature at the inlet to the device 20°C - fan speed III, heating medium temperature 110/90°C, air temperature at the inlet to the device 0°C; Slim E performance at power range: from 1N 230/50 to 3N 400/50

<sup>(3)</sup> RAL 9003 and 9005. Any RAL color upon request

## APPLICATION

The Slim curtain will work wherever doors are often opened, in shops, restaurants, service salons. Slim fits 99% of door openings. The curtain is designed for horizontal installation directly above the door opening and for vertical installation at the side parts of the opening.

## AVAILABLE TYPES OF UNITS:

- **3 LENGTHS**  
1 m, 1,5 m or 2 m
- **3 VERSIONS**  
W – water heat exchanger (1- or 2-rows)  
N – without heating elements („ambient“)  
E – electric heaters

## TECHNICAL DATA

### Air curtains

#### Slim

	SLIM E-100	SLIM W-100	SLIM N-100	SLIM E-150	SLIM W-150	SLIM N-150	SLIM E-200	SLIM W-200	SLIM N-200
Power supply [V/Hz]	230 / 50 or 3x400 / 50	230 / 50	230 / 50	230 / 50 or 3x400 / 50	230 / 50	230 / 50	230 / 50 or 3x400 / 50	230 / 50	230 / 50
Max. power consumption [kW]	5,0	0,12	0,14	9,0	0,17	0,2	12,0	0,22	0,23
Max. current consumption [A]	8,5	0,5	0,6	13,0	0,7	0,8	17,3	0,9	1
IP	20	20	20	20	20	20	20	20	20
Connection[“]	–	½	–	–	½	–	–	½	–
Air flow <sup>(1)</sup> [m <sup>3</sup> /h]	800–1300	750–1100	800–1400	1250–2200	1200–1950	1300–2300	1400–3000	1400–2850	1300–3000
Acoustic pressure level <sup>(2)</sup> [dB(A)] - 5 m	43–55,5	45–54,5	42,5–57	40–54	44–56	41–56	33,5–57	37–58	33,5–56
Acoustic power level <sup>(3)</sup> [dB(A)]	59–71,5	61–70,5	58,5–73	56–70	59–72	56–72	49,5–73	53–74	49,5–72
Heating capacity <sup>(4)</sup> [kW]	2–5	1,2–12,1	–	3–9	2,6–21,0	–	4–12	3,7–29,3	–
Max. water temperature [°C]	–	110	–	–	110	–	–	110	–
Max. operating pressure [MPa]	–	1,6	–	–	1,6	–	–	1,6	–
Curtain's air temperature rise <sup>(4)</sup> (ΔT) [°C]	4,0–24,0	3,0–32,5	–	6,0–32,0	4,0–32,0	–	6,0–36,0	4,0–30,5	–
Unit weight [kg]	15,1	16,2	14,7	19,6	21,5	19	24,6	26,9	23,8
Range <sup>(1)</sup> [m]	3,2	3,2	3,2	3,2	3,2	3,2	3,2	3,2	3,2

<sup>(1)</sup> according to ISO 27327-1

<sup>(2)</sup> the sound pressure level measured in a room with an average sound absorption capacity, 1500 m<sup>3</sup>; directivity factor Q = 2

<sup>(3)</sup> sound power level according to ISO 27327-2

<sup>(4)</sup> Slim W power and temperature range specified for the parameters: fan speed III, heating medium temperature 40/30°C air temperature at the inlet to the device 20°C - fan speed III, heating medium temperature 110/90°C air temperature at the inlet to the device 0°C; Slim E power range for operation at 1N 230/50 to operation at 3N 400/50

# INSTALLATION

1 set of brackets - 3 mounting possibilities



**BRACKETS FOR Slim**  
Invisible mounting system,  
for both vertical and  
horizontal mounting.



or

**RODS**  
In standard Slim air  
curtains have special  
mounting holes for  
installation with  
threaded rods.

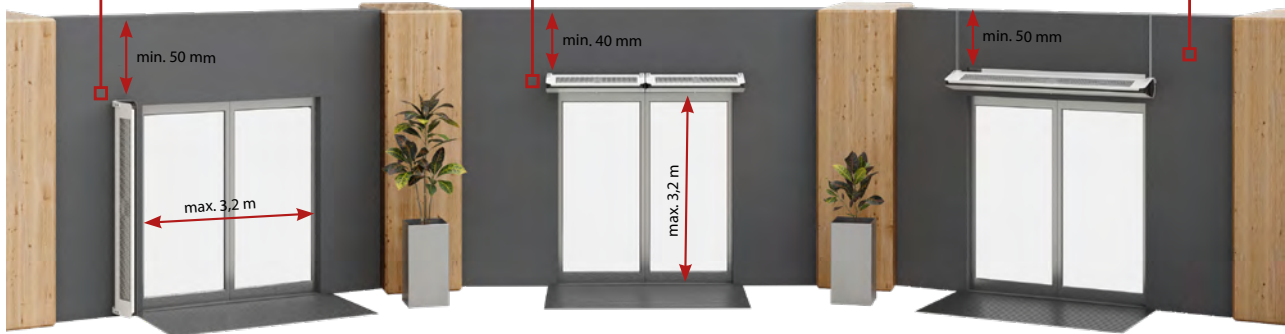

## DIMENSIONS

The thinnest air curtain on the market

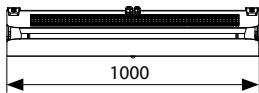

SLIM N|W|E-100

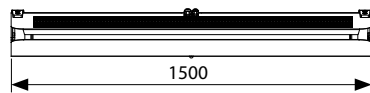

SLIM N|W|E-150

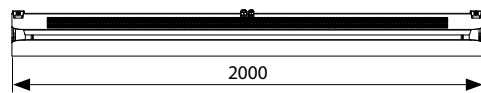

SLIM N|W|E-200

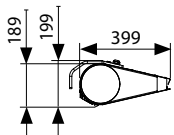

■ **CAD drawings** and documentation for all available versions of ELiS visit [www.flowair.com](http://www.flowair.com)



# ADVANTAGES OF Slim AIR CURTAINS

4i Solution

## I INTELLIGENT Intelligent savings

### Motion sensor

The built-in motion sensor activates the curtain when motion is detected in the vicinity of the device. No additional door sensor or other automation elements are needed. Additionally, you can limit or extend the sensor's area of operation yourself.

### Plug & Play

The Slim curtain has a built-in control for automatic operation in relation to the signal from the motion sensor. Thanks to this sensor, the device knows when to activate. Built-in switches on the side of the curtain allow you to adjust the air barrier to your needs.

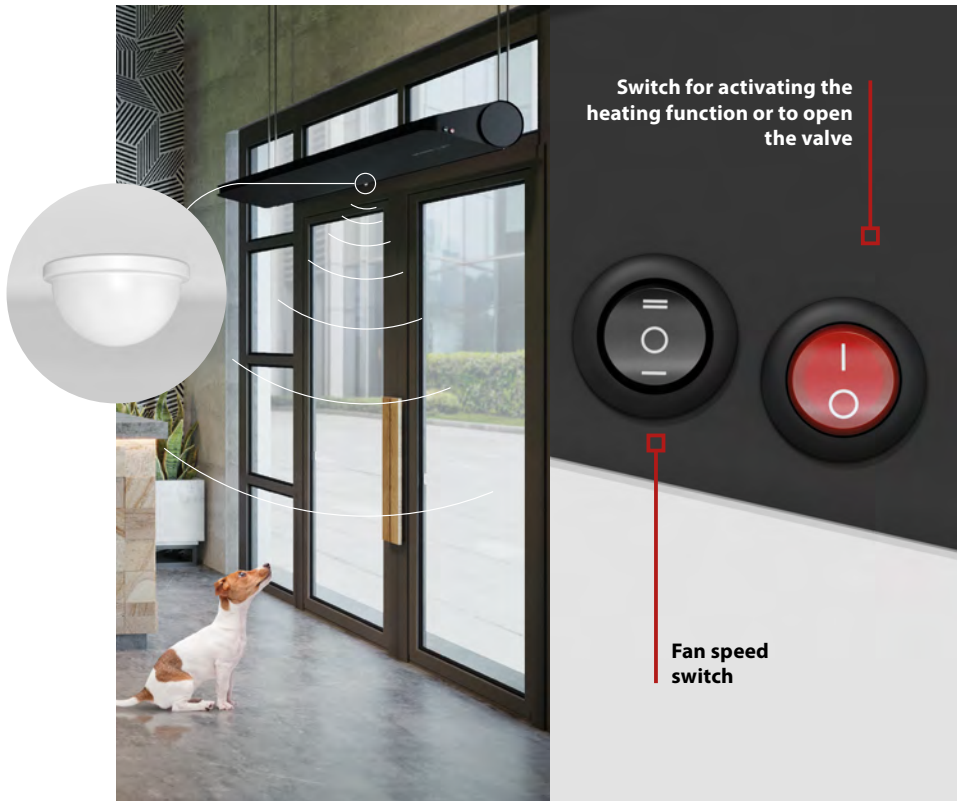

## I IMPROVING AIR Air quality improvement

The design of the Slim air curtain allows for full protection against unwanted air inflow across the entire width of the door opening. The device is designed to work with an external filter module, which improves air quality and protects the device against the ingress of dirt and other pollutants.

Filter type: Coarse 30%  
Thickness: 4mm





## INVISIBLE Discreetness in action

The Slim curtain has been designed to be unobtrusive. It works quietly even at top speed. It is aesthetic and thin - almost invisible.



Deep black



White with black elements



## IDEAL Perfect fit for your business

The Slim curtain will be a perfect fit for spaces where the doors are often opened and closed, for example in shops, restaurants and other commercial facilities.



### 99%

Perfect fit for 99% of door openings.

### 3,2 m

The recommended installation height; up to 3,2 m is enough to secure the door openings in most commercial facilities.

### 1 m = 100 cm

The thinnest curtain on the market. The device doesn't have any protruding side details - its length is always as stated. 100 cm Slim air curtain = 1 m.

# AVAILABLE OPTIONS UPON REQUEST

## TS + motion sensor



The solution will prove useful if you frequently change the curtain's settings and want to have the controller at your fingertips. Select the TS controller, which acts as a thermostat and switches on the heating elements.

## TS + door sensor



This solution will prove useful when the motion sensor cannot operate freely due to some obstacles (e.g. a suspended element under the air curtain). In this case the devices' control depends on the signal from door sensor.

## T-box



This solution will be useful when you want to connect the curtain to an intelligent building management system BMS. Choose this option if you need a weekly programmer or remote supervision over the operation of devices.

# CONNECTION DIAGRAMS

## PLUG&PLAY CONTROL

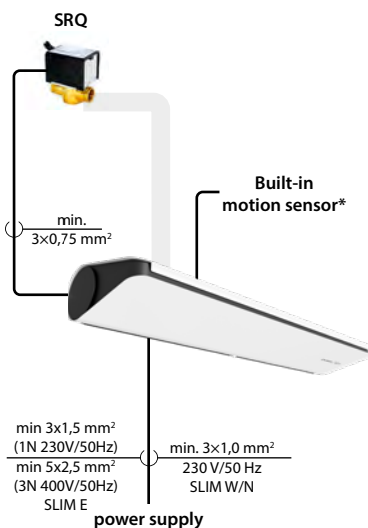

### ELEMENTS:

- **PLUG & PLAY** – Built-in motion sensor
- **SRQ** – valve with actuator (for SLIM W)

## TS CONTROLLER

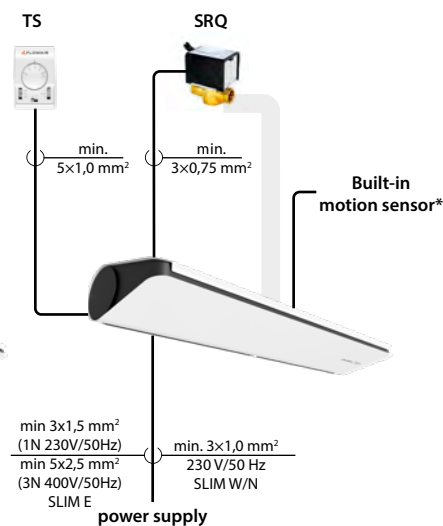

### ELEMENTS:

- **TS** – 3-step fan speed controller with thermostat
- **SRQ** – valve with actuator (for SLIM W)

## T-BOX CONTROLLER

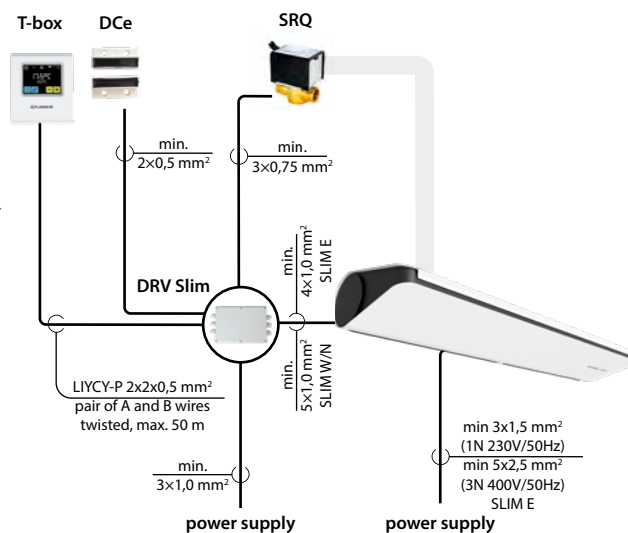

### ELEMENTS:

- **T-box** – intelligent controller with touch screen
- **DRV Slim** – external control module
- **DCe** – magnetic door sensor
- **SRQ** – valve with actuator (for SLIM W)

\* here is an option to use DCet door sensor instead of built-in motion sensor

# HEATING CAPACITIES

Tw1/Tw2 = 90/70°C					Tw1/Tw2 = 80/60°C					Tw1/Tw2 = 70/50°C					Tw1/Tw2 = 60/40°C				
Tp1	PT	Qw	Δpw	Tp2	Tp1	PT	Qw	Δpw	Tp2	Tp1	PT	Qw	Δpw	Tp2	Tp1	PT	Qw	Δpw	Tp2
[°C]	[kW]	[l/h]	[kPa]	[°C]	[°C]	[kW]	[l/h]	[kPa]	[°C]	[°C]	[kW]	[l/h]	[kPa]	[°C]	[°C]	[kW]	[l/h]	[kPa]	[°C]
<b>SLIM W-100</b>																			
<b>III step : V = 1100 m³/h</b>																			
0,0	9.4	414	5.2	25.5	0,0	8.1	354	4.0	22.0	0,0	6.7	293	3.0	18.0	0,0	5.3	231	2.0	14.5
10,0	8.2	362	4.1	32.0	10,0	6.8	301	3.0	28.5	10,0	5.5	239	2.1	24.5	10,0	4.1	177	1.3	21.0
20,0	7.0	309	3.1	38.5	20,0	5.6	247	2.1	35.0	20,0	4.2	185	1.3	31.5	20,0	2.8	120	0.6	27.5
<b>SLIM W-150</b>																			
<b>III step : V = 1950 m³/h</b>																			
0,0	16.5	726	19.2	25.0	0,0	14.2	624	15.0	21.5	0,0	11.9	522	11.3	18.0	0,0	9.6	420	7.9	15.0
10,0	14.4	637	15.2	32.0	10,0	12.2	534	11.4	28.5	10,0	9.9	431	8.0	25.0	10,0	7.5	328	5.1	21.5
20,0	12.4	547	11.5	38.5	20,0	10.1	443	8.1	35.0	20,0	7.7	339	5.2	31.5	20,0	5.4	234	2.8	28.0
<b>SLIM W-200</b>																			
<b>III step : V = 2850 m³/h</b>																			
0,0	23.0	1016	42.2	24.0	0,0	19.9	874	33.1	21.0	0,0	16.8	734	24.9	17.5	0,0	13.6	594	17.6	14.5
10,0	20.2	892	33.3	31.0	10,0	17.1	750	25.0	27.5	10,0	13.9	608	17.7	24.5	10,0	10.7	467	11.5	21.0
20,0	17.4	768	25.3	38.0	20,0	14.2	624	17.9	34.5	20,0	11.0	480	11.6	31.5	20,0	7.7	336	6.4	28.0

V – air flow  
 PT – heating capacity  
 Tp1 – inlet air temperature  
 Tp2 – outlet air temperature

Tw1 – inlet water temperature  
 Tw2 – outlet water temperature  
 Qw – water flow in the heat exchanger  
 Δpw – water pressure drop in the heat exchanger



## HEAT POWER CALCULATOR

Select a device for different parameters, scan QR code.

# AIR CURTAINS ELiS T

Range<sup>(1)</sup> [m]  
**4**

Heating capacity<sup>(2)</sup> [kW]  
**0,8–58,9**

Weight [kg]  
**20,7–37,5**

Casing  
**Steel, EPP,  
plastic,  
aluminium**

Air flow [m<sup>3</sup>/h]  
**1700–5300**

Colour<sup>(3)</sup>  
**Grey**



<sup>(1)</sup> According to ISO 27327-1

<sup>(2)</sup> T-W power and temperature range specified for the parameters: fan speed III, heating medium temperature 40/30°C air temperature at the inlet to the device 20°C - fan speed III, heating medium temperature 90/70°C air temperature at the inlet to the device 0°C;

<sup>(3)</sup> RAL 9007

## APPLICATION

Modern shape and small size makes it suitable to install the units both in representative and industrial buildings. ELiS T air curtains are designed for both horizontal mounting – directly above the door openings – and vertical mounting on the side parts of the door opening.

## AVAILABLE TYPES OF UNITS:

### 3 LENGTHS

1 m, 1,5 m or 2 m

### 3 VERSIONS

W – water heat exchanger (1- or 2-rows)

N – without heating elements („ambient“)

E – electric heaters

## TECHNICAL DATA

### Air curtains

#### ELiS T

	ELiS T-W- 100	ELiS T-W- 100 2R	ELiS T-N- 100	ELiS T-E- 100	ELiS T-W- 150	ELiS T-W- 150 2R	ELiS T-N- 150	ELiS T-E- 150	ELiS T-W- 200	ELiS T-W- 200 2R	ELiS T-N- 200	ELiS T-E- 200
Power supply [V/Hz]	230 / 50	230 / 50	230 / 50	3 x 400 / 50	230 / 50	230 / 50	230 / 50	3 x 400 / 50	230 / 50	230 / 50	230 / 50	3 x 400 / 50
Max. power consumption [kW]	0,38	0,38	0,39	7,5	0,4	0,4	0,42	11,5	0,44	0,44	0,46	15,5
Max. current consumption [A]	1,7	1,7	1,8	11	1,8	1,8	1,9	16,6	2,0	2,0	2,1	22,4
IP	21	21	21	21	21	21	21	21	21	21	21	21
Connection[“]	½“	½“	–	–	½“	½“	–	–	½“	½“	–	–
Air flow <sup>(1)</sup> [m <sup>3</sup> /h]	1900– 2300	1700– 2100	2100– 2900	1900– 2300	3100– 3900	2900– 3700	3200– 4000	3100– 3900	3200– 5100	2800– 4900	3300– 5300	3200– 5100
Acoustic pressure level <sup>(2)</sup> [dB(A)] - 5 m	58–60	57–59	61–63	58–60	58–61	55–60	58–64	58–61	58–62	56–61	58–65	58–62
Acoustic power level <sup>(3)</sup> [dB(A)]	73–75	72–74	76–78	73–75	73–76	70–75	73–79	73–76	73–77	71–76	73–80	73–77
Heating capacity <sup>(4)</sup> [kW]	0,8–12,9	3,2–24,7	–	7,1–7,5	2,6–23,2	6,8–43,9	–	11,0–11,5	4,3–31,4	9,5–58,9	–	14,9–15,5
Max. water temperature [°C]	95	95	–	–	95	95	–	–	95	95	–	–
Max. operating pressure [MPa]	1,6	1,6	–	–	1,6	1,6	–	–	1,6	1,6	–	–
Curtain's air temperature rise <sup>(4)</sup> (ΔT) [°C]	1–17	5–35	–	11–12	2–18	6–35	–	12–13	3–19	6–36	–	13–14
Unit weight [kg]	22,1	23,5	20,7	24,0	29,5	32,0	27,0	31,5	34,3	37,5	31,5	37,0
Range <sup>(1)</sup> [m]	4	4	4	4	4	4	4	4	4	4	4	4

<sup>(1)</sup> according to ISO 27327-1

<sup>(2)</sup> the sound pressure level measured in a room with an average sound absorption capacity, 1500 m<sup>3</sup>; directivity factor Q = 2

<sup>(3)</sup> sound power level according to ISO 27327-2

<sup>(4)</sup> T-W power and temperature range specified for the parameters: fan speed III, heating medium temperature 40/30°C air temperature at the inlet to the device 20°C - fan speed III, heating medium temperature 90/70°C air temperature at the inlet to the device 0°C; T-E power range for operation at fan speed I - fan speed III

# INSTALLATION



**BRACKET MPK**  
Possibility of vertical installation of ELiS T air curtains using brackets.



**RODS**  
ELiS T air curtains can be mounted using threaded rods.



or



**CONSOLE**  
Optional installation console enables easy and quick installation of the air curtain on the wall in two ways.

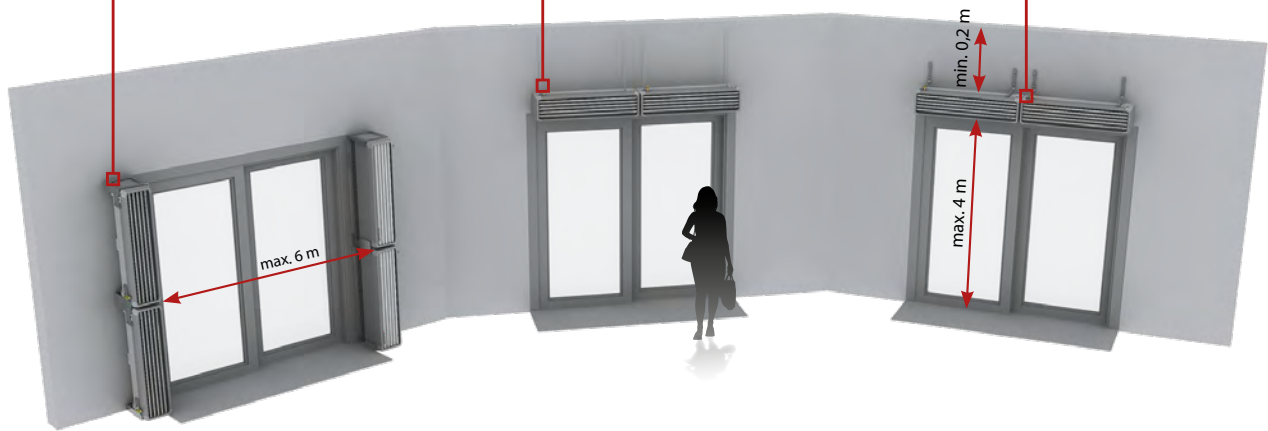

## DIMENSIONS

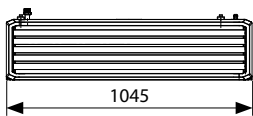

T-N|W|E-100

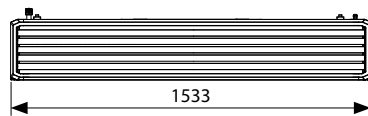

T-N|W|E-150

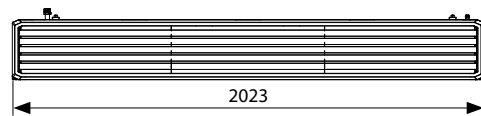

T-N|W|E-200

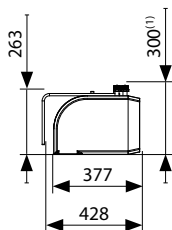

■ **CAD drawings** and documentation for all available versions of ELiS visit [www.flowair.com](http://www.flowair.com)



<sup>(1)</sup> the dimension refers to a curtain with an ELiS T-W exchanger

# CONNECTION DIAGRAMS

## TS CONTROLLER

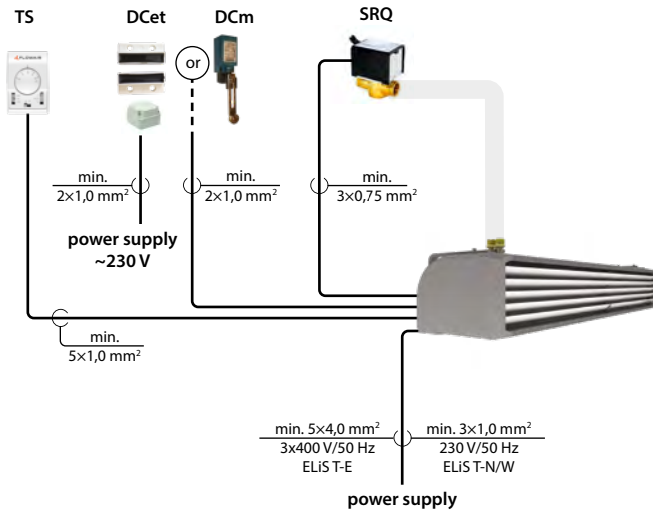

### ELEMENTS:

- **TS** – 3-step fan speed controller with thermostat
- **DCet** – magnetic door sensor with relay box
- **DCm** – mechanical door sensor
- **SRQ** – valve with actuator

## T-box CONTROLLER

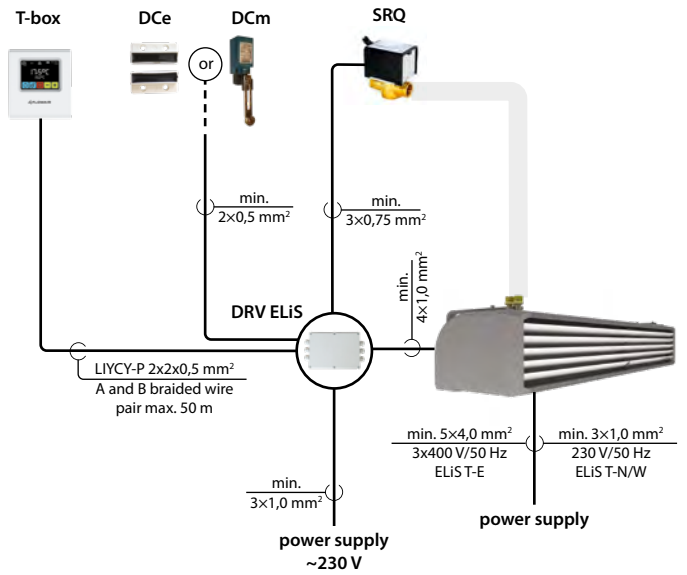

### ELEMENTS:

- **T-box** – intelligent controller with touch screen
- **DRV ELiS** – external control module
- **DCe** – magnetic door sensor
- **DCm** – mechanical door sensor
- **SRQ** – valve with actuator

## ELiS T – UNIVERSAL INSTALLATION

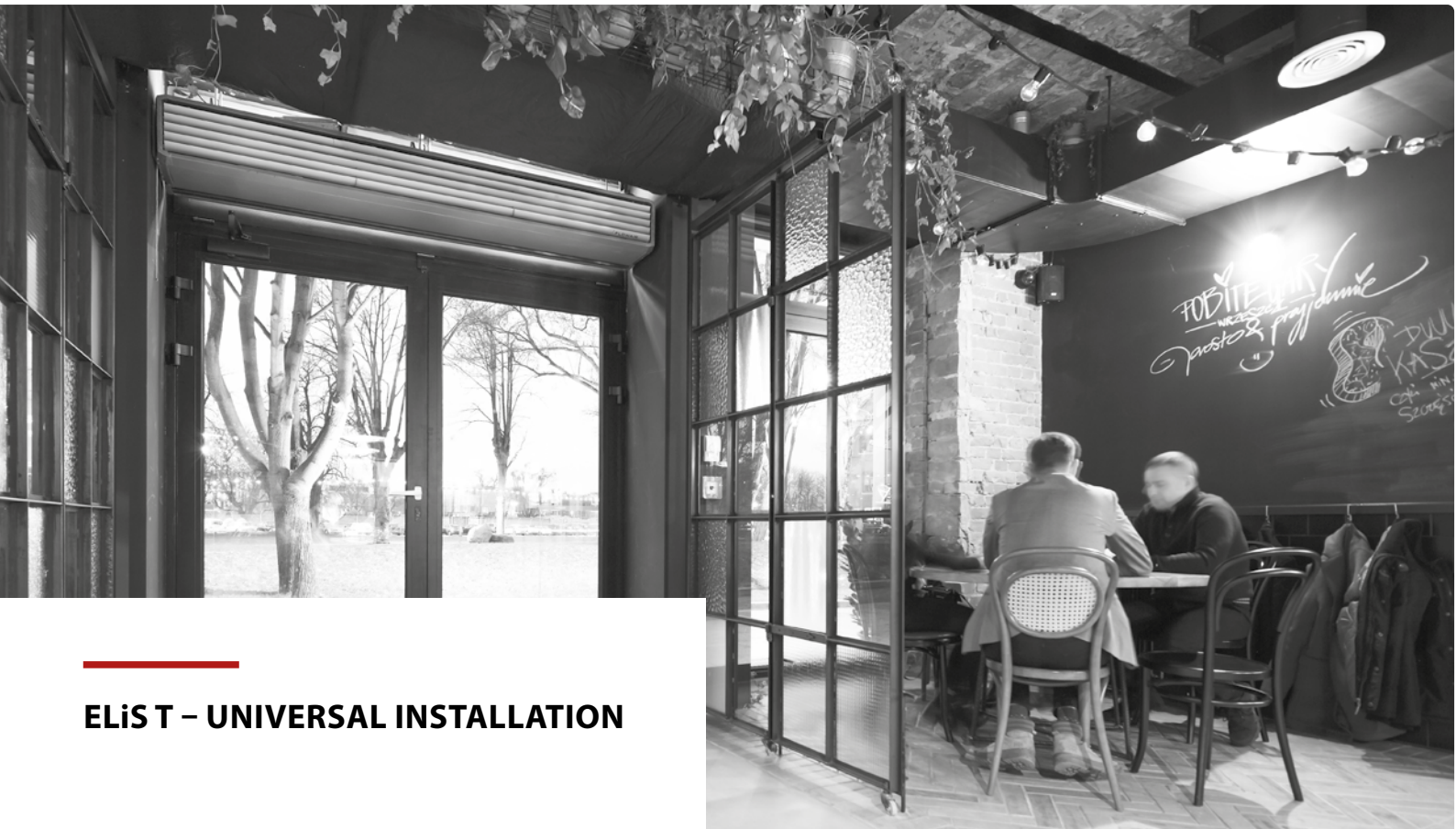

# HEATING CAPACITIES

Tw1/Tw2 = 90/70°C					Tw1/Tw2 = 80/60°C					Tw1/Tw2 = 70/50°C					Tw1/Tw2 = 60/40°C				
Tp1	PT	Qw	Δpw	Tp2	Tp1	PT	Qw	Δpw	Tp2	Tp1	PT	Qw	Δpw	Tp2	Tp1	PT	Qw	Δpw	Tp2
[°C]	[kW]	[l/h]	[kPa]	[°C]	[°C]	[kW]	[l/h]	[kPa]	[°C]	[°C]	[kW]	[l/h]	[kPa]	[°C]	[°C]	[kW]	[l/h]	[kPa]	[°C]
<b>ELiST-W-100</b>																			
<b>III step : V = 2300 m³/h</b>																			
0,0	12,9	571	2	17	0,0	10,8	476	1,5	14,0	0,0	8,7	379	1	11	0,0	6,3	276	0,6	8
10,0	11,1	492	1,5	24,5	10,0	9	395	1,1	21,5	10,0	6,8	296	0,7	18,5	10,0	4,2	183	0,3	15
20,0	9,3	411	1,1	32	20,0	7,1	314	0,7	29,	20,0	4,8	210	0,4	26	20,0	1,7	73	0,1	22
<b>ELiST-W-150</b>																			
<b>III step : V = 3900 m³/h</b>																			
0,0	23,2	1026	7,2	17,5	0,0	19,8	870	5,5	15,0	0,0	16,3	714	4	12	0,0	12,8	556	2,6	9
10,0	20,2	892	5,6	25	10,0	16,7	735	4	22,5	10,0	13,2	578	2,7	20	10,0	9,6	417	1,6	16,5
20,0	17,2	757	4,1	32,5	20,0	13,6	599	2,8	30,0	20,0	10	439	1,6	27,5	20,0	6,2	272	0,07	24
<b>ELiST-W-200</b>																			
<b>III step : V = 5100 m³/h</b>																			
0,0	31,4	1387	14,5	18	0,0	26,9	1183	11,1	15,0	0,0	22,4	980	8,1	12,5	0,0	17,8	776	5,5	10
10,0	27,4	1211	11,3	26	10,0	22,9	1005	8,2	23,0	10,0	18,3	801	5,6	20,5	10,0	13,6	595	3,4	18
20,0	23,4	1033	8,4	33	20,0	18,8	826	5,8	30,5	20,0	14,4	619	3,5	27,5	20,0	9,4	408	1,7	25
<b>ELiST-W-100 2R</b>																			
<b>III step : V = 2100 m³/h</b>																			
0,0	22,6	998	1,57	32	0,0	18,9	832	1,16	27,0	0,0	15,1	662	0,79	21	0,0	11	479	0,46	16
10,0	19,5	858	1,19	37	10,0	15,7	691	0,83	32,0	10,0	11,8	517	0,51	27	10,0	6,96	304	0,2	19
20,0	16,3	718	0,86	43	20,0	12,5	547	0,54	37,0	20,0	8,3	362	0,27	31	20,0	3,17	138	0,5	24
<b>ELiST-W-150 2R</b>																			
<b>III step : V = 3700 m³/h</b>																			
0,0	41,5	1833	5,9	33	0,0	35,4	1555	4,48	28	0,0	29,2	1276	3,22	23	0,0	22,8	994	2,1	18
10,0	36,1	1592	4,6	39	10,0	29,9	1313	3,29	34	10,0	23,6	1032	2,2	29	10,0	17,1	746	1,27	24
20,0	30,6	1351	3,4	44	20,0	24,3	1069	2,27	39	20,0	17,9	785	1,34	34	20,0	11,1	483	0,58	29
<b>ELiST-W-200 2R</b>																			
<b>III step : V = 4900 m³/h</b>																			
0,0	56,5	2494	11,95	34	0,0	48,4	2127	9,17	29	0,0	40,3	1762	6,7	24	0,0	32	1396	4,54	19
10,0	49,3	2174	9,28	40	10,0	41,1	1806	6,8	35	10,0	32,9	1439	4,64	30	10,0	24,5	1069	2,81	25
20,0	42	1854	6,93	45	20,0	33,7	1483	4,75	40	20,0	25,4	1111	2,91	35	20,0	16,8	732	1,43	30

V – air flow  
 PT – heating capacity  
 Tp1 – inlet air temperature  
 Tp2 – outlet air temperature

Tw1 – inlet water temperature  
 Tw2 – outlet water temperature  
 Qw – water flow in the heat exchanger  
 Δpw – water pressure drop in the heat exchanger



## HEAT POWER CALCULATOR

Select a device for different parameters, scan QR code.

# AIR CURTAINS

## ELiS B



Range<sup>(1)</sup> [m]  
**5**

Heating capacity<sup>(2)</sup> [kW]  
**0,9–59,0**

Weight [kg]  
**31,7–53,2**

Casing  
**Steel,  
plastic,  
aluminium**

Air flow [m<sup>3</sup>/h]  
**2000–6600**

Colour<sup>(3)</sup>  
**White**



**SPECIAL PAINTING  
ON REQUEST**

<sup>(1)</sup> According to ISO 27327-1

<sup>(2)</sup> B-W power and temperature range specified for the parameters: fan speed III, heating medium temperature 40/30°C air temperature at the inlet to the device 20°C - fan speed III, heating medium temperature 90/70°C air temperature at the inlet to the device 0°C; B-E power range for operation fan speed I - fan speed III

<sup>(3)</sup> RAL 9016

### APPLICATION

ELiS B air curtains are dedicated for shops, restaurants, exhibition rooms. Units are designed for installation in the ceilings. Advantage is the possibility to install in the existing ceiling without cutting additional holes.

### AVAILABLE TYPES OF UNITS:

- **3 LENGTHS**  
1 m, 1,5 m or 2 m
- **3 VERSIONS**  
W – water heat exchanger (1- or 2-rows)  
N – without heating elements („ambient“)  
E – electric heaters

### TECHNICAL DATA

#### Air curtains

#### ELiS B

	ELiS B-W-100	ELiS B-W-100 2R	ELiS B-N-100	ELiS B-E-100	ELiS B-W-150	ELiS B-W-150 2R	ELiS B-N-150	ELiS B-E-150	ELiS B-W-200	ELiS B-W-200 2R	ELiS B-N-200	ELiS B-E-200
Power supply [V/Hz]	230 / 50	230 / 50	230 / 50	3 x 400 / 50	230 / 50	230 / 50	230 / 50	3 x 400 / 50	230 / 50	230 / 50	230 / 50	3 x 400 / 50
Max. power consumption [kW]	0,34	0,34	0,42	7,5	0,36	0,36	0,42	11,5	0,38	0,38	0,49	15,5
Max. current consumption [A]	1,5	1,5	1,9	11	1,6	1,6	2	16,6	1,7	1,7	2,2	22,4
IP	21	21	21	21	21	21	21	21	21	21	21	21
Connection[“]	½“	½“	–	–	½“	½“	–	–	½“	½“	–	–
Air flow <sup>(1)</sup> [m <sup>3</sup> /h]	2200–2600	2000–2400	2300–3500	2200–2600	3200–4000	3000–3800	3200–4800	3200–4000	4000–5200	3800–4900	3600–6600	4000–5200
Acoustic pressure level <sup>(2)</sup> [dB(A)] - 5 m	55–58	55–57	61–65	55–58	57–62	56–60	58–65	57–62	58–63	56–61	59–66	58–63
Acoustic power level <sup>(3)</sup> [dB(A)]	70–73	70–72	76–80	70–73	72–77	71–75	73–80	72–77	73–78	71–76	74–81	73–78
Heating capacity <sup>(4)</sup> [kW]	0,9–13,8	3,5–26,7	–	7,1–7,5	2,6–23,6	6,9–44,6	–	11,0–11,5	4,4–31,8	9,5–59,0	–	14,9–15,5
Max. water temperature [°C]	95	95	–	–	95	95	–	–	95	95	–	–
Max. operating pressure [MPa]	1,6	1,6	–	–	1,6	1,6	–	–	1,6	1,6	–	–
Curtain's air temperature rise <sup>(4)</sup> (ΔT) [°C]	1–16	4–33	–	11–12	2–18	5–35	–	12–13	3–18	6–36	–	13–14
Unit weight [kg]	32,3	33,7	31,7	34,5	41,2	43,7	38,9	42,4	50	53,2	47,2	53,2
Range <sup>(1)</sup> [m]	5	5	5	5	5	5	5	5	5	5	5	5

<sup>(1)</sup> according to ISO 27327-1

<sup>(2)</sup> the sound pressure level measured in a room with an average sound absorption capacity, 1500 m<sup>3</sup>; directivity factor Q = 2

<sup>(3)</sup> sound power level according to ISO 27327-2

<sup>(4)</sup> B-W power and temperature range specified for the parameters: fan speed III, heating medium temperature 40/30°C air temperature at the inlet to the device 20°C - fan speed III, heating medium temperature 90/70°C air temperature at the inlet to the device 0°C; B-E power range for operation at fan speed I - fan speed III



# INSTALLATION

## BRACKETS

Brackets with mounting holes for installation using threaded rods are included.



Installation of the unit doesn't require additional holes in the ceiling.

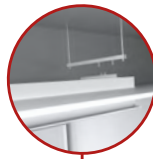

Access from the front makes installation, connection and cleaning of the air curtain much easier.

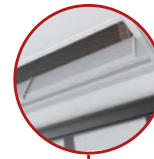

## DIMENSIONS

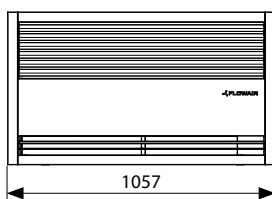

B-N|W|E-100

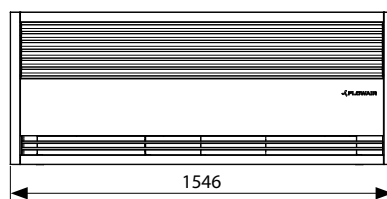

B-N|W|E-150

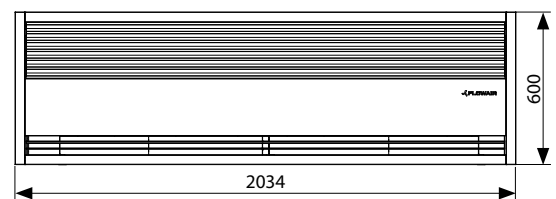

B-N|W|E-200

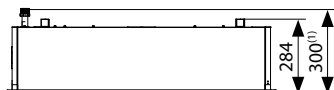

■ **CAD drawings** and documentation for all available versions of ELiS visit [www.flowair.com](http://www.flowair.com)



<sup>1)</sup> the dimension refers to a curtain with an ELiS B-W exchanger

# CONNECTION DIAGRAMS

## TS CONTROLLER

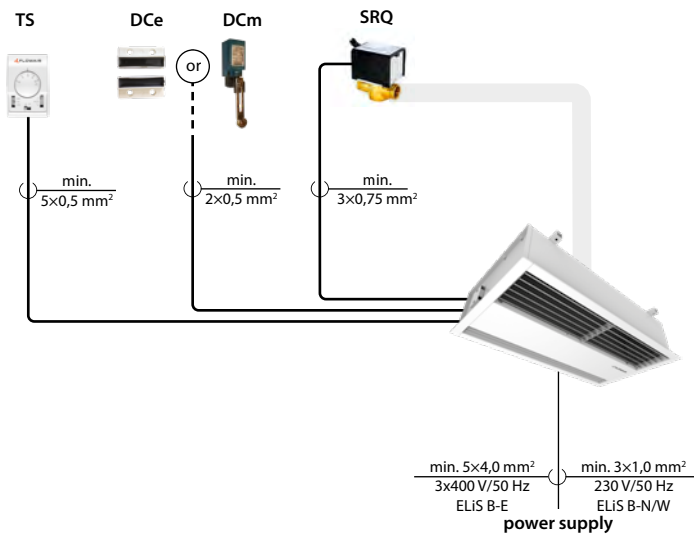

### ELEMENTS:

- **TS** – 3-step fan speed controller with thermostat
- **DCe** – magnetic door sensor
- **DCm** – mechanical door sensor
- **SRQ** – valve with actuator

## T-box CONTROLLER

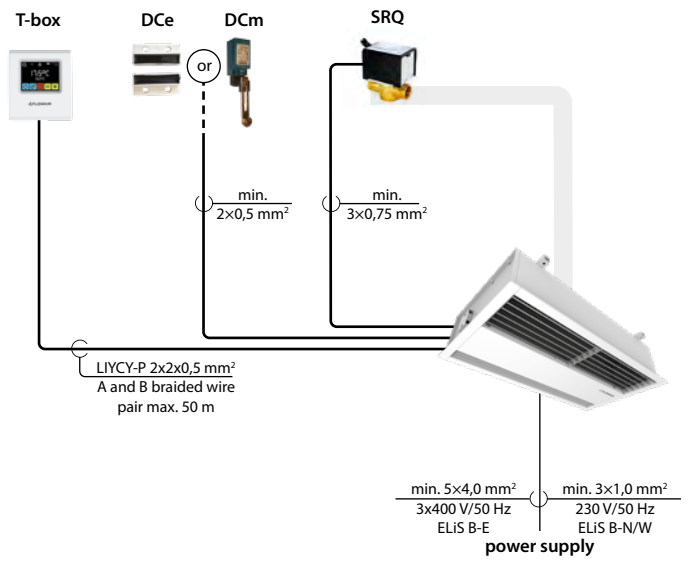

### ELEMENTS:

- **T-box** – intelligent controller with touch screen
- **DCe** – magnetic door sensor
- **DCm** – mechanical door sensor
- **SRQ** – valve with actuator

## ELIS B – RECESSED AIR CURTAINS



# HEATING CAPACITIES

Tw1/Tw2 = 90/70°C					Tw1/Tw2 = 80/60°C					Tw1/Tw2 = 70/50°C					Tw1/Tw2 = 60/40°C				
Tp1	PT	Qw	Δpw	Tp2	Tp1	PT	Qw	Δpw	Tp2	Tp1	PT	Qw	Δpw	Tp2	Tp1	PT	Qw	Δpw	Tp2
[°C]	[kW]	[l/h]	[kPa]	[°C]	[°C]	[kW]	[l/h]	[kPa]	[°C]	[°C]	[kW]	[l/h]	[kPa]	[°C]	[°C]	[kW]	[l/h]	[kPa]	[°C]
<b>ELiS B-W-100</b>																			
<b>III step : V = 2600 m³/h</b>																			
0,0	13,8	609	2,3	15,5	0,0	11,5	507	1,7	13,0	0,0	9,2	404	1,2	10,5	0,0	6,8	295	0,7	7,5
10,0	11,9	524	1,7	24,5	10,0	9	395	1,1	21,5	10,0	7,2	316	0,7	18,0	10,0	4,6	198	0,3	15,0
20,0	9,9	438	1,2	31,0	20,0	7,6	334	0,8	28,5	20,0	5,1	225	0,4	25,0	20,0	1,7	74	0,1	22,0
<b>ELiS B-W-150</b>																			
<b>III step : V = 4000 m³/h</b>																			
0,0	23,5	1039	7,4	17,5	0,0	20,0	881	5,6	15,0	0,0	16,5	723	4,0	12,5	0,0	13,0	563	2,7	9,5
10,0	20,5	904	5,7	25,0	10,0	17,0	745	4,1	22,5	10,0	13,4	585	2,8	20,0	10,0	9,7	423	1,6	17,0
20,0	17,4	767	4,2	32,5	20,0	13,8	607	2,8	30,0	20,0	10,2	445	1,7	27,5	20,0	6,3	276	0,7	24,5
<b>ELiS B-W-200</b>																			
<b>III step : V = 5200 m³/h</b>																			
0,0	31,8	1402	14,7	18,0	0,0	27,7	1195	11,3	15,5	0,0	22,5	990	8,3	13,0	0,0	18,0	784	5,6	10,5
10,0	27,7	1223	11,5	25,7	10,0	23,1	1016	8,4	22,5	10,0	18,5	809	5,7	20,5	10,0	13,8	601	3,5	18,0
20,0	23,6	1043	8,8	33,0	20,0	19,0	834	5,9	30,5	20,0	14,3	625	3,6	28,0	20,0	9,5	412	1,8	25,0
<b>ELiS B-W-100 2R</b>																			
<b>III step : V = 2400 m³/h</b>																			
0,0	24,5	1080	1,82	30	0,0	20,5	900	1,34	27,0	0,0	11,8	716	0,91	20	0,0	12	521	0,53	15
10,0	21	928	1,38	36	10,0	17	747	0,95	31	10,0	12,8	560	0,58	26	10,0	7,8	341	0,25	20
20,0	17,6	776	0,99	41	20,0	13,5	592	0,63	36	20,0	9	395	0,31	31	20,0	3,3	142	0,05	24
<b>ELiS B-W-150 2R</b>																			
<b>III step : V = 3800 m³/h</b>																			
0,0	42,2	1863	6,1	33	0,0	36	1580	4,6	28	0,0	29,6	1296	3,3	23	0,0	23,2	1010	2,2	18
10,0	39,4	1618	4,7	38,5	10,0	30,4	1334	3,4	33,5	10,0	24	1049	2,3	28,5	10,0	17,4	758	1,3	23,5
20,0	31,1	1373	3,5	44	20,0	24,7	1086	2,3	39	20,0	18,2	797	1,4	34	20,0	11,3	492	0,6	28,5
<b>ELiS B-W-200 2R</b>																			
<b>III step : V = 4900 m³/h</b>																			
0,0	57,2	2524	12,2	34	0,0	49	2153	9,37	29	0,0	40,8	1783	6,85	24	0,0	32,4	1413	4,64	19
10,0	49,9	2200	9,49	39	10,0	41,6	1828	6,95	34	10,0	33,3	1456	4,74	30	10,0	24,8	1082	2,87	25
20,0	42,5	1876	7,09	45	20,0	34,2	1501	4,85	40	20,0	25,7	1125	2,97	35	20,0	17	741	1,46	30

V – air flow  
 PT – heating capacity  
 Tp1 – inlet air temperature  
 Tp2 – outlet air temperature

Tw1 – inlet water temperature  
 Tw2 – outlet water temperature  
 Qw – water flow in the heat exchanger  
 Δpw – water pressure drop in the heat exchanger





## HEAT POWER CALCULATOR

Select a device for different parameters, scan QR code.

# AIR CURTAINS

## ELiS A

Range<sup>(1)</sup> [m]  
 **3**

Heating capacity<sup>(2)</sup> [kW]  
 **2,8–32,2**

Weight [kg]  
 **18,4–39,0**

Casing  
 **Steel with polyester coating**

Air flow [m<sup>3</sup>/h]  
 **850–3500**

Colour<sup>(3)</sup>  
 **Silver or white**



**SPECIAL PAINTING ON REQUEST**

<sup>(1)</sup> According to ISO 27327-1

<sup>(2)</sup> A-W power and temperature range specified for the parameters: fan speed III, heating medium temperature 40/30°C air temperature at the inlet to the device 20°C - fan speed III, heating medium temperature 90/70°C air temperature at the inlet to the device 0°C; A-E power range for operation fan speed I - fan speed III

<sup>(3)</sup> RAL 9006 or RAL 9016

## APPLICATION

Representative rooms such as shops, restaurants, exhibition rooms, etc. ELiS A devices are designed for horizontal installation directly above door openings. They produce an air barrier that reduces heat/cool losses.

## AVAILABLE TYPES OF UNITS:

- **3 LENGTHS**  
1 m, 1,5 m or 2 m
- **3 VERSIONS**  
W – water heat exchanger  
N – without heating elements („ambient“)  
E – electric heaters

## TECHNICAL DATA

### Air curtains

#### ELiS A

	ELiS A-W-100	ELiS A-N-100	ELiS A-E-100	ELiS A-W-150	ELiS A-N-150	ELiS A-E-150	ELiS A-W-200	ELiS A-N-200	ELiS A-E-200
Power supply [V/Hz]	230 / 50	230 / 50	3 x 400 / 50	230 / 50	230 / 50	3 x 400 / 50	230 / 50	230 / 50	3 x 400 / 50
Max. power consumption [kW]	0,17	0,17	7,0	0,25	0,25	10,7	0,34	0,34	15,0
Max. current consumption [A]	0,72	0,72	10,0	1,1	1,1	15,5	1,45	1,45	21,5
IP	21/F	21/F	21/F	21/F	21/F	21/F	21/F	21/F	21/F
Connection[“]	½“	–	–	½“	–	–	½“	–	–
Air flow <sup>(1)</sup> [m <sup>3</sup> /h]	850–1500	850–1500	850–1500	1650–2500	1650–2500	1650–2500	2400–3500	2400–3500	2400–3500
Acoustic pressure level <sup>(2)</sup> [dB(A)] - 5 m	44–57	44–57	44–57	45–58	45–58	45–58	46–59	46–59	46–59
Acoustic power level <sup>(3)</sup> [dB(A)]	59–72	59–72	59–72	60–73	60–73	60–73	61–74	61–74	61–74
Heating capacity <sup>(4)</sup> [kW]	2,8–20,1	–	6,6–7,0	2,8–22,9	–	10,2–10,7	4,6–32,2	–	14,4–15,0
Max. water temperature [°C]	95	–	–	95	–	–	95	–	–
Max. operating pressure [MPa]	1,6	–	–	1,6	–	–	1,6	–	–
Curtain's air temperature rise <sup>(4)</sup> (ΔT) [°C]	6,0–40,0	–	25–27	3,0–27,0	–	21–24	4,0–27,0	–	18–22
Unit weight [kg]	20,9	18,4	21,4	28,3	25,3	28,5	37,1	33,6	39,0
Range <sup>(1)</sup> [m]	3	3	3	3	3	3	3	3	3

<sup>(1)</sup> according to ISO 27327-1

<sup>(2)</sup> the sound pressure level measured in a room with an average sound absorption capacity, 1500 m<sup>3</sup>; directivity factor Q = 2

<sup>(3)</sup> sound power level according to ISO 27327-2

<sup>(4)</sup> A-W power and temperature range specified for the parameters: fan speed III, heating medium temperature 40/30°C air temperature at the inlet to the device 20°C - fan speed III, heating medium temperature 90/70°C air temperature at the inlet to the device 0°C; A-E power range for operation at fan speed I - fan speed III

# INSTALLATION



**RODS**  
ELiS A air curtains have special mounting holes for installation using threaded rods.



**CONSOLE**  
Two ways of mounting the console.



or



## DIMENSIONS

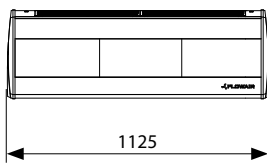

A-N|W|E-100

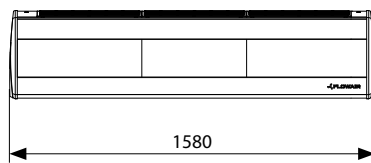

A-N|W|E-150

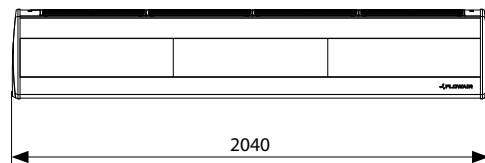

A-N|W|E-200

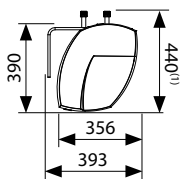

■ For CAD drawings, Revit files and documentation for all available versions of ELiS visit [www.flowair.com](http://www.flowair.com)



<sup>1)</sup> the dimension refers to a curtain with an ELiS A-W exchanger

# CONNECTION DIAGRAMS

## TS CONTROLLER

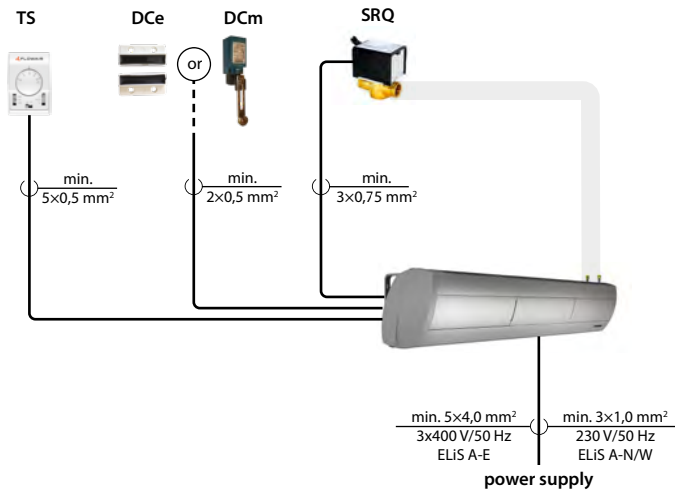

### ELEMENTS:

- **TS** – 3-step fan speed controller with thermostat
- **DCe** – magnetic door sensor
- **DCm** – mechanical door sensor
- **SRQ** – valve with actuator

## T-BOX CONTROLLER

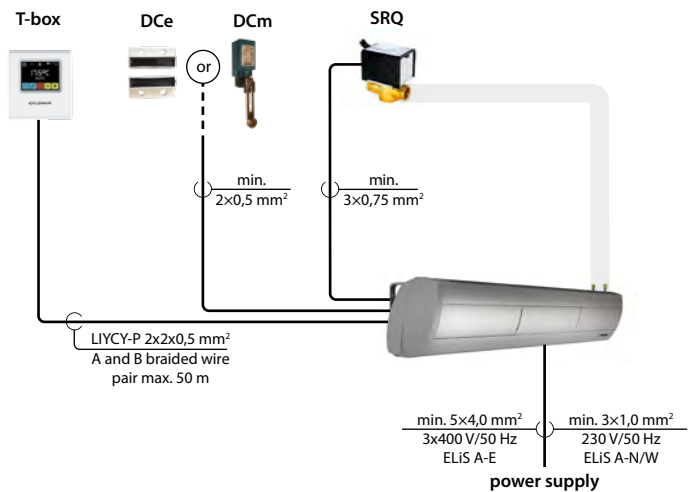

### ELEMENTS:

- **T-box** – intelligent controller with touch screen
- **DCe** – magnetic door sensor
- **DCm** – mechanical door sensor
- **SRQ** – valve with actuator

**ELiS A – REPRESENTATIVE AND AESTHETIC SPACES**



# HEATING CAPACITIES

Tw1/Tw2 = 90/70°C					Tw1/Tw2 = 80/60°C					Tw1/Tw2 = 70/50°C					Tw1/Tw2 = 60/40°C				
Tp1	PT	Qw	Δpw	Tp2	Tp1	PT	Qw	Δpw	Tp2	Tp1	PT	Qw	Δpw	Tp2	Tp1	PT	Qw	Δpw	Tp2
[°C]	[kW]	[l/h]	[kPa]	[°C]	[°C]	[kW]	[l/h]	[kPa]	[°C]	[°C]	[kW]	[l/h]	[kPa]	[°C]	[°C]	[kW]	[l/h]	[kPa]	[°C]

## ELiS A-W-100

### III step : V = 1500 m³/h

0,0	20,1	887	8,1	40	0,0	17,3	759	6,2	34	0,0	14,4	631	4,6	28	0,0	11,5	502	3,2	23
10,0	17,6	775	6,3	44	10,0	14,7	646	4,7	39	10,0	11,8	517	3,2	33	10,0	8,9	87	2,0	27
20,0	15,0	663	4,7	49	20,0	12,1	533	3,3	43	20,0	9,2	402	2,0	38	20,0	6,1	267	1,0	32

## ELiS A-W-150

### III step : V = 2500 m³/h

0,0	22,9	1011	8,3	27	0,0	19,6	861	6,3	23	0,0	16,2	709	4,6	19	0,0	12,8	556	3,0	15
10,0	20	881	6,5	34	10,0	16,6	728	4,7	30	10,0	13,2	576	3,1	26	10,0	9,7	421	1,8	21
20,0	17	748	4,8	40	20,0	13,5	593	3,2	36	20,0	10	439	1,9	32	20,0	6,4	279	0,9	27

## ELiS A-W-200

### III step : V = 3500 m³/h

0,0	32,2	1419	18	27	0,0	27,6	1212	13,6	23	0,0	23	1007	10	20	0,0	18,4	801	6,7	16
10,0	28	1240	14	34	10,0	23,5	1031	10,1	30	10,0	18,9	824	6,9	26	10,0	14,1	616	4,2	22
20,0	24	1054	10,3	40	20,0	19,2	845	7	36	20,0	14,6	637	4,3	32	20,0	9,8	425	2,2	28

V – air flow  
 PT – heating capacity  
 Tp1 – inlet air temperature  
 Tp2 – outlet air temperature

Tw1 – inlet water temperature  
 Tw2 – outlet water temperature  
 Qw – water flow in the heat exchanger  
 Δpw – water pressure drop in the heat exchanger



## HEAT POWER CALCULATOR

Select a device for different parameters, scan QR code.

# AIR CURTAIN-FAN HEATERS

## ELiS DUO

Range<sup>(1)</sup> [m]  
 **2,5**

Heating capacity<sup>(2)</sup> [kW]  
 **3,5–33,2**

Weight [kg]  
 **23,9–41,1**

Casing  
 **Steel with polyester coating**

Air flow [m<sup>3</sup>/h]  
 **1200–3700**

Colour<sup>(3)</sup>  
 **Silver or white**



**SPECIAL PAINTING ON REQUEST**

<sup>(1)</sup> According to ISO 27327-1

<sup>(2)</sup> DUO-W power and temperature range specified for the parameters: fan speed III, heating medium temperature 40/30°C air temperature at the inlet to the device 20°C - fan speed III, heating medium temperature 90/70°C air temperature at the inlet to the device 0°C; DUO-E power range for operation fan speed I - fan speed III

<sup>(3)</sup> RAL 9006 or RAL 9016

### APPLICATION

Device combines functionality of the air curtain and the fan heater. Modern design of the unit makes it especially suitable for buildings with high aesthetic values. Where there is a need of heating a room while providing an effective air barrier in the door opening, e.g. small grocery stores, petrol stations etc.

### AVAILABLE TYPES OF UNITS:

- **2 LENGTHS**  
1 m or 2 m
- **2 VERSIONS**  
W – water heat exchanger  
E – electric heaters

### TECHNICAL DATA

#### Air curtain-fan heaters ELiS DUO

	DUO-W-100	DUO-W-200	DUO-E-100
Power supply [V/Hz]	230 / 50	230 / 50	3 x 400 / 50
Max. power consumption [kW]	0,25	0,43	10,1
Max. current consumption [A]	1,1	1,85	14,7
IP	21	21	21
Connection ["]	½"	½"	½"
Air flow curtain heater <sup>(1)</sup> [m <sup>3</sup> /h]	800-1400   400-700	1700-3000   400-700	800-1400   400-700
Acoustic pressure level <sup>(2)</sup> [dB(A)]	45-58	47-60	45-58
Acoustic power level <sup>(3)</sup> [dB(A)]	60-73	62-75	60-73
Heating capacity <sup>(4)</sup> [kW]	3,5-24,8	4,7 -33,2	9,2-10,1
Max. water temperature [°C]	95	95	–
Max. operating pressure [MPa]	1,6	1,6	–
Curtain's air temperature rise <sup>(4)</sup> (ΔT) [°C]	5-35	4-27	20-23
Unit weight [kg]	3,9	41,1	28,5
Range <sup>(1)</sup> [m]	2,5	2,5	2,5

<sup>(1)</sup> according to ISO 27327-1

<sup>(2)</sup> the sound pressure level measured in a room with an average sound absorption capacity, 1500 m<sup>3</sup>; directivity factor Q = 2

<sup>(3)</sup> sound power level according to ISO 27327-2

<sup>(4)</sup> DUO-W power and temperature range specified for the parameters: fan speed III, heating medium temperature 40/30°C air temperature at the inlet to the device 20°C - fan speed III, heating medium temperature 90/70°C air temperature at the inlet to the device 0°C; DUO-E power range for operation at fan speed I - fan speed III



# INSTALLATION



**RODS**  
ELiS DUO air curtains have special mounting holes for installation using threaded rods.



**CONSOLE**  
Two ways of console mounting.



or

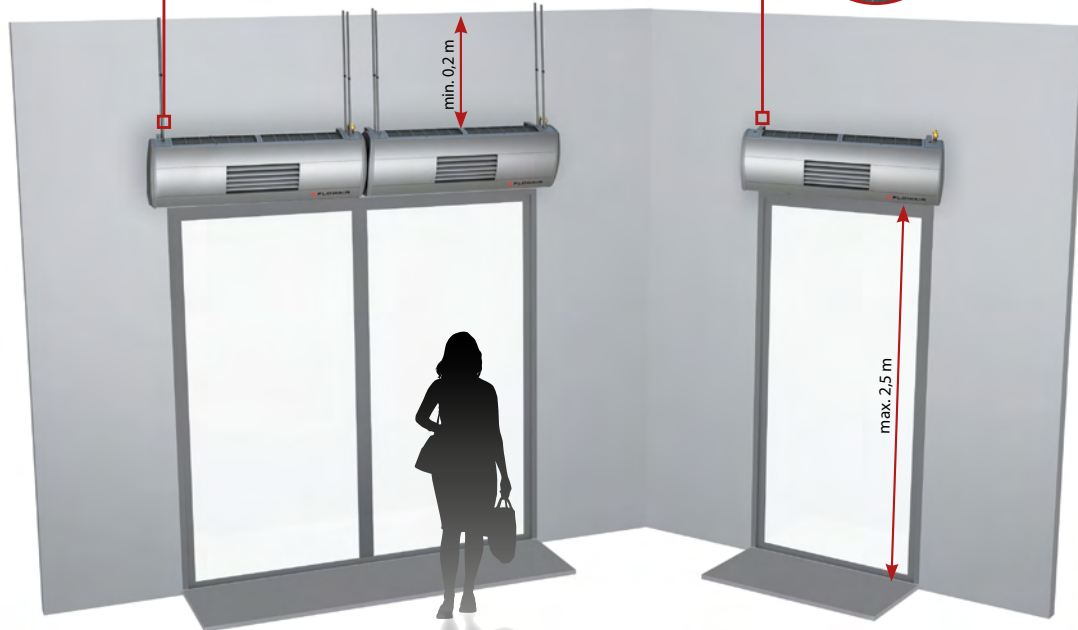

## DIMENSIONS

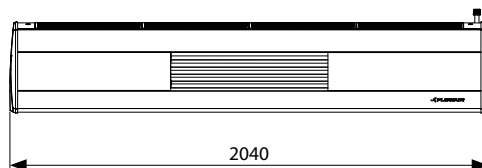
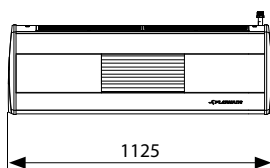

DUO-W|E-100

DUO-W-200

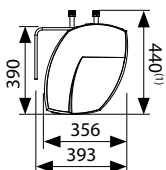

■ **CAD drawings** and documentation for all available versions of ELiS visit [www.flowair.com](http://www.flowair.com)



<sup>(1)</sup> the dimensions refer to the ELiS DUO-W unit with water exchanger

# CONNECTION DIAGRAM

## T-box CONTROLLER

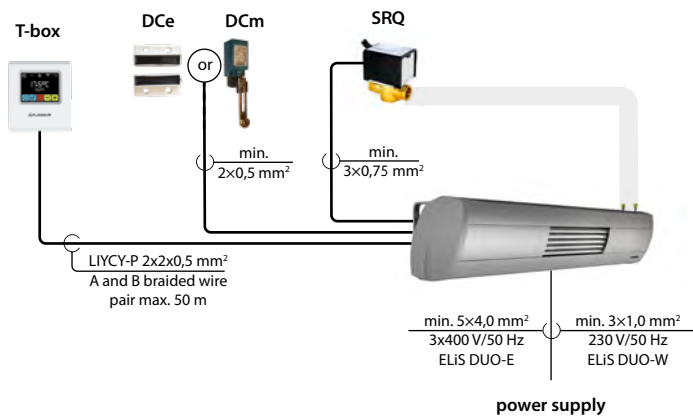

### ELEMENTS:

- **T-box** – intelligent controller with touch screen
- **DCe** – magnetic door sensor
- **DCm** – mechanical door sensor
- **SRQ** – valve with actuator

## POSSIBILITY OF INTEGRATION OF DEVICES WITH FLOWAIR SYSTEM

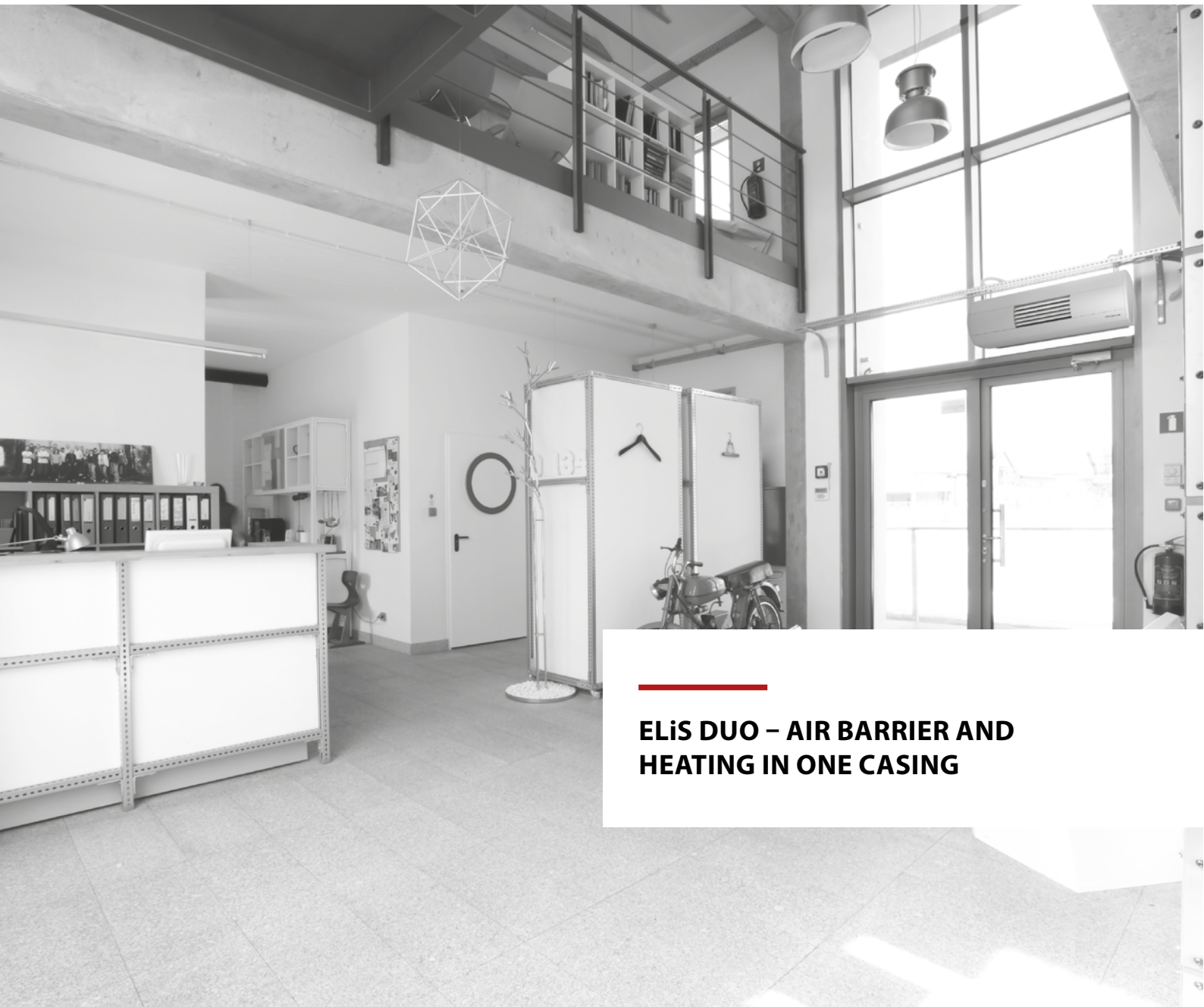

## ELIS DUO – AIR BARRIER AND HEATING IN ONE CASING

# HEATING CAPACITIES

Tw1/Tw2 = 90/70°C							Tw1/Tw2 = 70/50°C						Tw1/Tw2 = 60/40°C					
Tp1	PK	PN	PC	Qw	Δpw	Tp2	PK	PN	PC	Qw	Δpw	Tp2	PK	PN	PC	Qw	Δpw	Tp2
[°C]	[kW]	[kW]	[kW]	[l/h]	[kPa]	[°C]	[kW]	[kW]	[kW]	[l/h]	[kPa]	[°C]	[kW]	[kW]	[kW]	[l/h]	[kPa]	[°C]

## ELiS DUO-W-100

### III step: V 2100 m³/h (curtain = 1400 m³/h; heater = 700 m³/h)

0	16,5	8,3	24,8	1095	11,9	35	11,9	5,9	17,8	778	6,7	25	9,5	4,7	14,2	620	4,6	20
10	14,5	7,2	21,7	956	9,3	41	9,7	4,9	14,6	638	4,7	31	7,3	3,7	11	477	2,9	26
20	12,3	6,2	18,5	817	7	46	7,5	3,8	11,3	496	3	36	5,1	2,5	7,6	331	1,5	31

## ELiS DUO-W-200

### III step: V 3700 m³/h (curtain = 3000 m³/h; heater = 700 m³/h)

0	26,6	6,6	33,2	1465	18,9	27	19,0	4,8	23,8	1 039	10,6	19	15,2	3,8	19	826	7,2	15
10	23,2	5,8	29	1280	14,7	33	15,6	3,9	19,5	851	7,3	25,5	11,7	2,9	14,6	637	4,5	21,5
20	19,8	5,0	24,8	1094	11	40	12,1	3,0	15,1	661	4,6	32	8,1	2,0	10,1	441	2,3	28

- V – air flow
- PK – heating capacity of curtain
- PN – heating capacity of fan heater
- PC – heating capacity of fan heater and curtain
- PT – heating capacity
- Tp1 – inlet air temperature

- Tp2 – outlet air temperature
- Tw1 – inlet water temperature
- Tw2 – outlet water temperature
- Qw – water flow in the heat exchanger
- Δpw – water pressure drop in the heat exchanger



### HEAT POWER CALCULATOR

Select a device for different parameters, scan QR code.

# AIR CURTAINS ELiS G

Range<sup>(1)</sup> [m]  
**7,5**

Heating capacity<sup>(2)</sup> [kW]  
**5,0–74,2**

Weight [kg]  
**43,0–67,0**

Casing  
**Galvanized steel**

Air flow [m<sup>3</sup>/h]  
**4100–8600**

Colour  
**Grey, silver**



**SPECIAL PAINTING  
ON REQUEST**

<sup>(1)</sup> According to ISO 27327-1

<sup>(2)</sup> G-W power and temperature range specified for the parameters: fan speed III, heating medium temperature 40/30°C air temperature at the inlet to the device 20°C - fan speed III, heating medium temperature 90/70°C air temperature at the inlet to the device 0°C; G-E power range for operation fan speed I - fan speed III

## APPLICATION

Warehouses, halls, logistics centers. ELiS G devices are intended for horizontal and vertical installation. They create an air barrier that reduces the various losses associated with the exchange of air between the room and the outside area.

## AVAILABLE TYPES OF UNITS:

- **3 LENGTHS**  
0,5 m, 1,5 m or 2 m
- **3 VERSIONS**  
W – water heat exchanger (1- or 2-rows)  
N – without heating elements („ambient“)  
E – electric heaters

## TECHNICAL DATA

### Air curtains

#### ELiS G

	G-N-50	G-W-150	G-W-150 2R	G-N-150	G-E-150	G-W-200	G-W-200 2R	G-N-200	G-E-200
Power supply [V/Hz]	230 / 50	230 / 50	230 / 50	230 / 50	3 x 400 / 50	230 / 50	230 / 50	230 / 50	3 x 400 / 50
Max. power consumption [kW]	0,34	0,69	0,69	0,69	12,0	1,0	1,0	1,0	20,0
Max. current consumption [A]	1,4	2,8	2,8	2,8	17,0	4,2	4,2	4,2	29,0
IP	54	54	54	54	54	54	54	54	54
Connection["]	–	¾"	¾"	–	–	¾"	¾"	–	–
Air flow <sup>(1)</sup> [m <sup>3</sup> /h]	1100–2500	4000–6200	3500–5700	4300–6500	4100–6300	5100–8100	4600–7600	5400–8600	5200–8200
PAcoustic pressure level <sup>(2)</sup> [dB(A)] - 5 m	44–64	45–66	45–66	45–66	45–66	46–68	46–68	46–68	46–68
Acoustic power level <sup>(3)</sup> [dB(A)]	59–79	60–81	60–81	60–81	60–81	61–83	61–83	61–83	61–83
Heating capacity <sup>(4)</sup> [kW]	–	5,0–34,8	9,0–65,2	–	9,0–12,0	5,5–38,9	10,1–74,2	–	16,5–20,0
Max. water temperature [°C]	–	130	130	–	–	130	130	–	–
Max. operating pressure [MPa]	–	1,6	1,6	–	–	1,6	1,6	–	–
Curtain's air temperature rise <sup>(4)</sup> (ΔT) [°C]	–	2–16	5–32	–	7–12	2–15	4–29	–	7–12
Unit weight [kg]	19,3	47,4	51,8	43,0	49,8	62,0	66,4	58,0	67,0
Range <sup>(1)</sup> [m]	7,5	7,0	7,0	7,5	7,0	7,0	7,0	7,5	7,0

<sup>(1)</sup> according to ISO 27327-1

<sup>(2)</sup> the sound pressure level measured in a room with an average sound absorption capacity, 1500 m<sup>3</sup>; directivity factor Q = 2

<sup>(3)</sup> sound power level according to ISO 27327-2

<sup>(4)</sup> G-W power and temperature range specified for the parameters: fan speed III, heating medium temperature 40/30°C air temperature at the inlet to the device 20°C - fan speed III, heating medium temperature 90/70°C air temperature at the inlet to the device 0°C; G-E power range for operation at fan speed I - fan speed III

# INSTALLATION

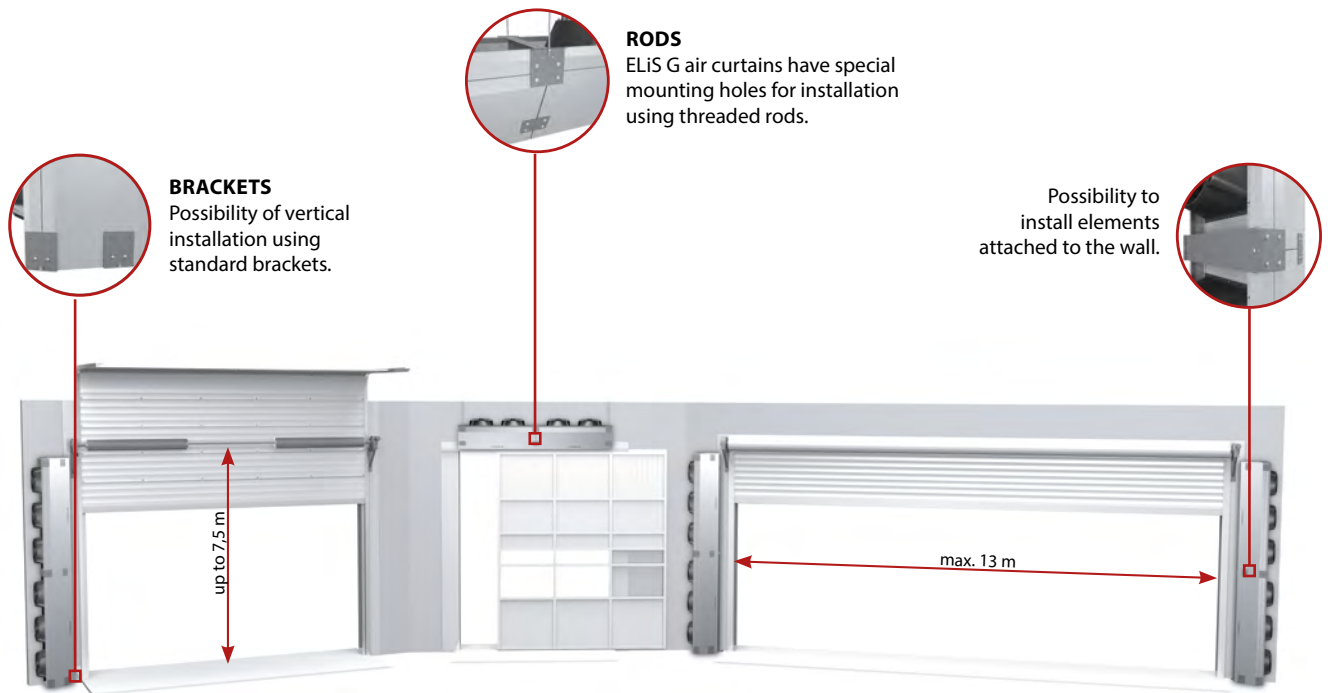

## DIMENSIONS

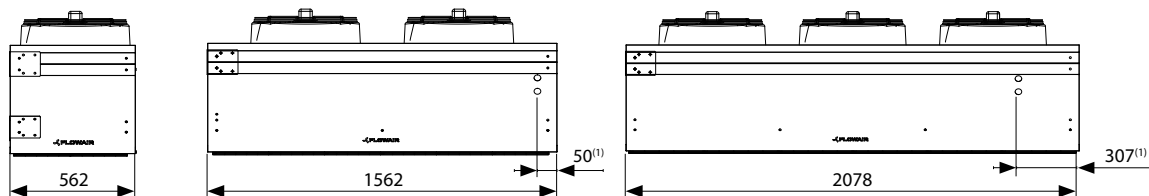

G-50

G-150

G-200

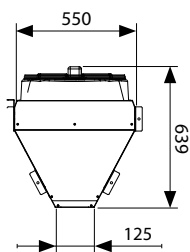

■ For CAD drawings, Revit files and documentation for all available versions of ELiS visit [www.flowair.com](http://www.flowair.com)



<sup>(1)</sup> the dimension refers to ELiS G-W curtain with water heat exchanger

# CONNECTION DIAGRAMS

## TS CONTROLLER

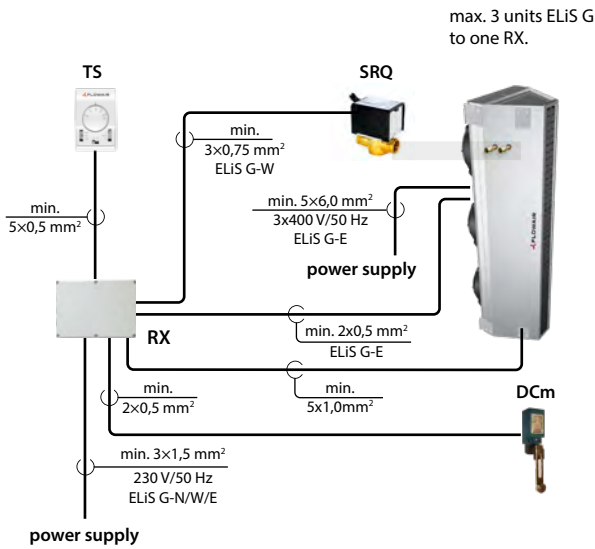

### ELEMENTS:

- **TS** – 3-step fan speed controller with thermostat (can control up to 1 pc. of ELiS G without using RX)
- **RX** – signal splitter for 3 ELiS G curtains
- **DCm** – mechanical door sensor
- **SRQ** – valve with actuator

## T-box CONTROLLER

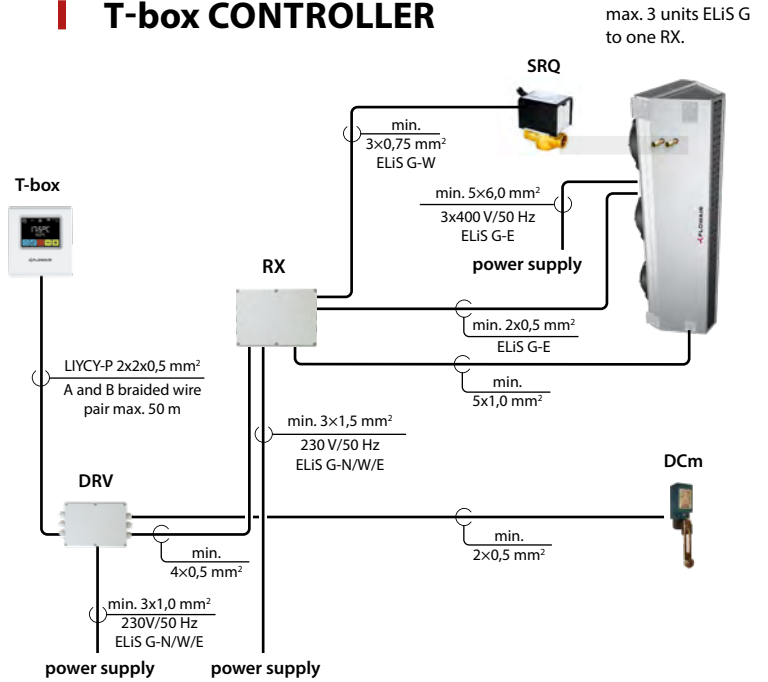

### ELEMENTS:

- **T-box** – intelligent controller with touch screen
- **DRV ELiS** – external control module
- **RX** – signal splitter for 3 ELiS G curtains
- **DCm** – mechanical door sensor
- **SRQ** – valve with actuator



**ELiS G – WHEN RANGE IS PRIORITY**

# HEATING CAPACITIES

Tw1/Tw2 = 90/70°C					Tw1/Tw2 = 80/60°C					Tw1/Tw2 = 70/50°C					Tw1/Tw2 = 60/40°C				
Tp1	PT	Qw	Δpw	Tp2	Tp1	PT	Qw	Δpw	Tp2	Tp1	PT	Qw	Δpw	Tp2	Tp1	PT	Qw	Δpw	Tp2
[°C]	[kW]	[l/h]	[kPa]	[°C]	[°C]	[kW]	[l/h]	[kPa]	[°C]	[°C]	[kW]	[l/h]	[kPa]	[°C]	[°C]	[kW]	[l/h]	[kPa]	[°C]
<b>ELiS G-W-150</b>																			
<b>III step : V = 6200 m³/h</b>																			
0,0	34,8	1530	9	15,5	0,0	29,9	1310	7	13,5	0,0	25	1090	6	11	0,0	20,1	880	4	9
10,0	29,5	1300	6	23,5	10,0	24,8	1090	6	21,5	10,0	20	870	4	19,5	10,0	15,1	660	4	17
20,0	24,5	1080	6	32	20,0	19,8	870	4	29,5	20,0	15,1	660	4	27,5	20,0	10,4	450	4	25
<b>ELiS G-W-200</b>																			
<b>III step : V = 8100 m³/h</b>																			
0,0	38,9	1720	9	14,5	0,0	33,5	1470	8	12	0,0	28	1220	6	10	0,0	22,4	980	5	8
10,0	33,1	1460	8	22,5	10,0	27,7	1220	6	20,5	10,0	22,3	980	5	18,5	10,0	16,9	740	5	16,5
20,0	27,4	1210	6	31	20,0	22,1	970	5	28,5	20,0	16,9	740	5	26,5	20,0	11,6	500	2	24,5
<b>ELiS G-W-150 2R</b>																			
<b>III step : V = 5700 m³/h</b>																			
0,0	65,2	2870	4	32	0,0	56	2460	4	27	0,0	46,6	2040	3	23	0,0	37,3	1620	2	18
10,0	55,3	2440	4	38	10,0	46,2	2030	3	33	10,0	37,1	1620	2	29	10,0	27,9	1220	2	24
20,0	45,7	2020	3	44	20,0	36,8	1620	2	39	20,0	28	1220	2	35	20,0	19	830	2	30
<b>ELiS G-W-200 2R</b>																			
<b>III step : V = 7600 m³/h</b>																			
0,0	74,2	3270	5	29	0,0	63,5	2790	4	25	0,0	52,9	2310	4	21	0,0	42,2	1840	3	17
10,0	62,8	2770	4	36	10,0	52,5	2300	4	31	10,0	42,1	1840	3	27	10,0	31,6	1380	3	23
20,0	52	2290	4	42	20,0	41,9	1840	3	38	20,0	31,7	1390	3	33	20,0	21,4	930	2	29

V – air flow  
 PT – heating capacity  
 Tp1 – inlet air temperature  
 Tp2 – outlet air temperature  
 Tw1 – inlet water temperature  
 Tw2 – outlet water temperature  
 Qw – water flow in the heat exchanger  
 Δpw – water pressure drop in the heat exchanger

# CONTROL SYSTEMS

for ELiS air curtains



## TS CONTROLLER basic version

Simplest regulation of 3-step fans. Fan heater operation is controlled by 3-step fan speed controller with thermostat.



## T-box CONTROLLER BMS version

Intelligent regulation system of 3-step fans. Speed regulation of energy-efficient fan via T-box controller.

## Air curtains ELiS and Slim

### Controlling options

Type of devices

Manual 3-step air flow regulation

### Modes

Heating/Ventilation

Operation depending on door sensor and temperature

Weekly programmer

BMS

Switch-off delay

Idle speed mode

INTEGRATION WITH FLOWAIR SYSTEM

### Max. number of connected units

Via controller

Via additional splitters

### Type of fan

AC – standard 3-step fan

TS Controller

T-box Controller

Slim, ELiS T, ELiS B, ELiS A, ELiS G

Slim<sup>(1)</sup>, ELiS T<sup>(2)</sup>, ELiS A, ELiS B, ELiS DUO, ELiS G<sup>(1)</sup>

✓

✓

✓

✓

✓

✓

✓

✓

✓

✓

✓

✓

✓

✓

✓

ELiS T – 2,  
ELiS A / B / DUO – 5,  
Slim/ELiS G – 1

31

ELiS G – 9,  
Slim / ELiS T – 18

n/d

✓

✓

<sup>(1)</sup> External control module DRV Slim required

<sup>(2)</sup> External control module DRV ELiS required



# CONTROL ELEMENTS

## DOOR SENSORS



Door sensors inform the control system about the opening / closing of the door.

Compatibility of sensors with ELiS air curtains

Sensor	Slim	ELiS T	ELiS B	ELiS A	ELiS DUO	ELiS G
DCet	✓	✓				
DCe			✓	✓	✓	
DCm		✓	✓	✓	✓	✓

## VALVES SRQ



Two or three-way valves with an electric actuator are available to control the flow of the heating medium.

Compatibility of valves with ELiS air curtains

Valve	Slim	ELiS T	ELiS B	ELiS A	ELiS DUO	ELiS G
SRQ2d 1/2"	✓	✓	✓	✓	✓	
SRQ2d 3/4"						✓
SRQ3d 1/2"	✓	✓	✓	✓	✓	
SRQ3d 3/4"						✓

## RX SPLITTERS

Control signal distributor for connecting several ELiS G air curtains with 3-stage fans to one controller.



The maximum number of devices supported by one controller

Splitter	Slim	ELiS T	ELiS G
1 pcs. RX	6 <sup>(1)</sup>	6	3
2 pcs. RX	12 <sup>(1)</sup>	12	6
3 pcs. RX	18 <sup>(1)</sup>	18	9

# INSTALLATION ELEMENTS

## CONSOLE ELiS



For horizontal mounting ELiS T, ELiS A, curtain heater ELiS DUO. Available in silver or white colours.

## MPK SET

for ELiS T



For vertical mounting ELiS T curtain. Available in silver color.

## BRACKETS Slim



For horizontal or vertical installation of the Slim air curtain. Available in white or black.

# SYSTEM FLOWAIR

mini BMS at your finger tips

**T-box**  
intelligent controller  
with touch screen



**LEO BMS**  
fan heaters



**LEO KM**  
mixing chamber

## INTEGRATION OF DEVICES

SYSTEM FLOWAIR is an intelligent solution which makes it possible to integrate the devices into a system with only one controller. T-box offers many necessary functions for effective management of a heating-ventilating system. These function were previously reserved for an extensive Building Management System (BMS).



Control of devices with  
one T-box

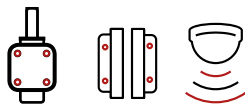

Local regulation  
of devices



Advanced control of  
ventilating and heating  
devices

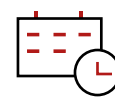

Control the devices  
according to your time  
schedule and individual  
needs



Antifreeze protects the  
devices against  
low temperatures

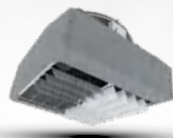

**LEO D BMS**  
destratifiers



**ELiS and Slim**  
air curtains



**OXeN**  
ventilation unit with heat  
recovery

## I DELAY TIME AND IDLE SPEED

The function of the curtain off delay time allows the curtain to be automatically turned off after the set time has been counted down. The idle speed of the curtain allows the curtain to be set when the door is closed at reduced capacity for a pre-set time. After the set time has been deducted, the curtain is switched off.

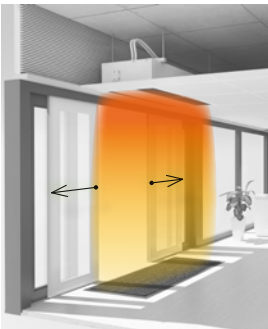

■ 3<sup>rd</sup> speed

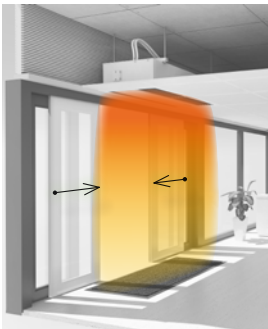

■ 3<sup>rd</sup> speed



■ 1<sup>st</sup> speed/ 1<sup>st</sup> minute

■ curtain idle speed



■ curtain delay time



**FIND OUT MORE!**

Get to know SYSTEM FLOWAIR - check how the curtain delay time and idle speed works.



ul. Chwaszczyńska 135  
81-571 Gdynia

Tel. +48 58 627 57 20

for inquiries:  
[export@flowair.pl](mailto:export@flowair.pl)

