

Description and application

Round swirl diffuser NWO - 3 on the round panel is used for ventilation and air conditioning industrial and public buildings with a height of 2.5 m - 4.5 m, such as offices, hotels, cinemas, conference rooms, supermarkets .

They are characterized by easy assembly in suspended ceilings, plenum boxes or directly on circular ducts.

Assembly is done using visible screws on the edge of the faceplate or using a central mounting. By appropriate location of the slots in the faceplate we get a swirling motion to the air flow.

By using movable plastic blades it can also adjust the flow direction of air flow.

Round swirl diffuser has Hygienic Certificate HK/K/0522/01/2016

Material and workmanship

Diffusers are made of galvanized sheet steel powder coated, standard on the white color 9016 or on request to any color from the RAL palette and special execution of stainless steel or aluminum. NWO-2 in supply air version have plastic blades located in each of the slots, with individually settings. Blades are standard in color black (on request there is possible to put the blades in white). Version extract air don't have a blades regulators.

Size

The diffusers are manufactured on order. Examples dimensions of the diffusers are given in the table.

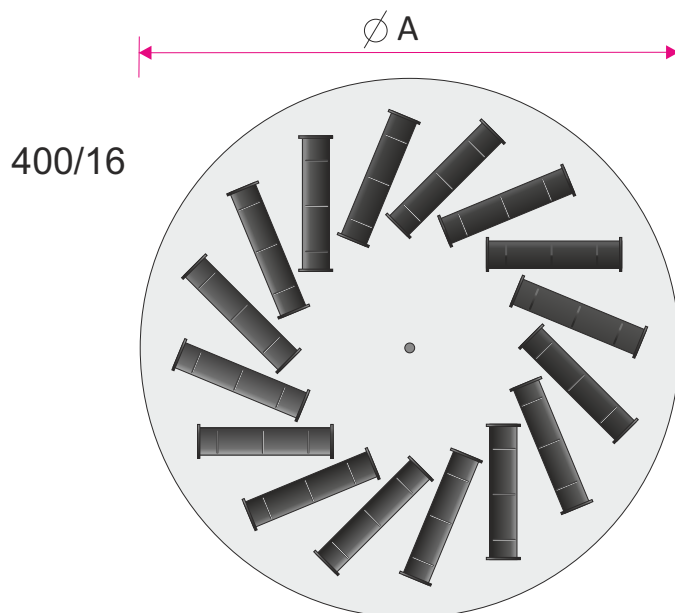

Size A	Quantity of blades	Aef(m ²)
300	8	0,012
400	8	0,012
400	16	0,024
500	8	0,012
500	16	0,024
500	24	0,036
600	24	0,036
595	24	0,036
600	32	0,048
595	32	0,048
600	48	0,072
595	48	0,072
625	24	0,036
625	32	0,048
625	48	0,072
825	72	0,108

Technical data

Quick selection diffusers NWO-3 for LWA<40dB
(in parenthesis the number of plastic blades).

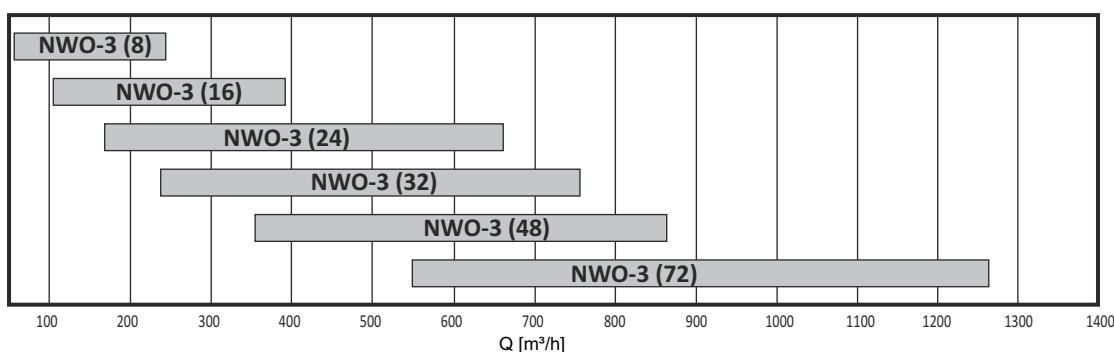

Dimensions - examples of the arrangement blades

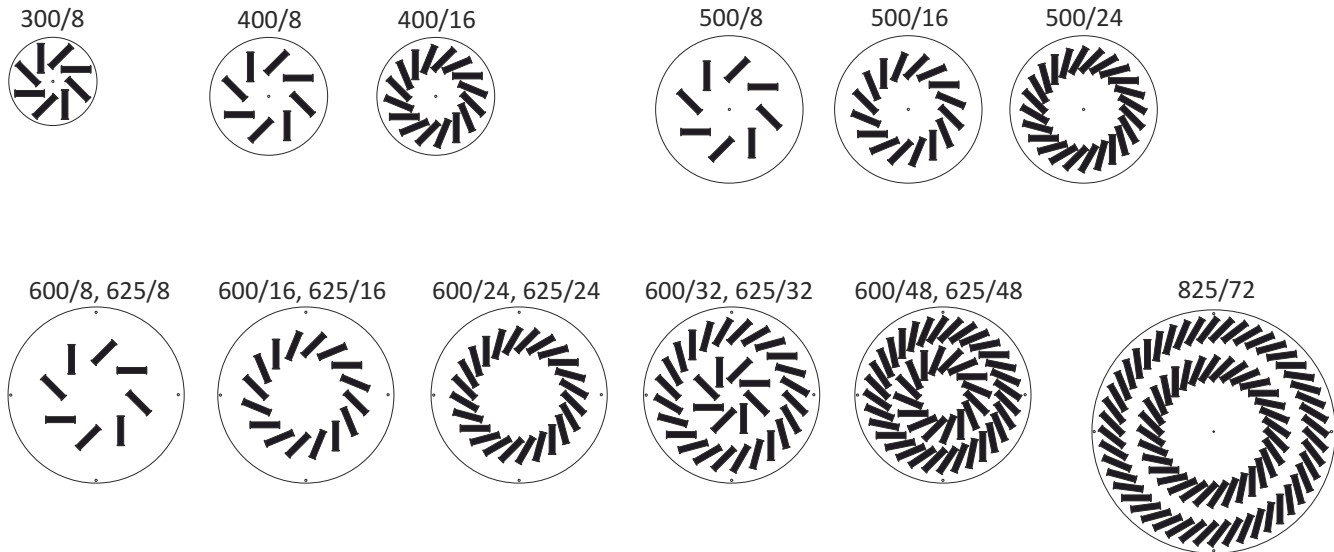

Accessories - plenum box

Plenum box is made of galvanized steel. On request it can be equipped with a damper control onto the connected spigot. The plenum box can be isolated inside with rubber (acoustic) or outside with mineral wool (thermal). In the standard height of the plenum box is adapted to size of the spigot or diffuser size (you can specify the height of the plenum box).

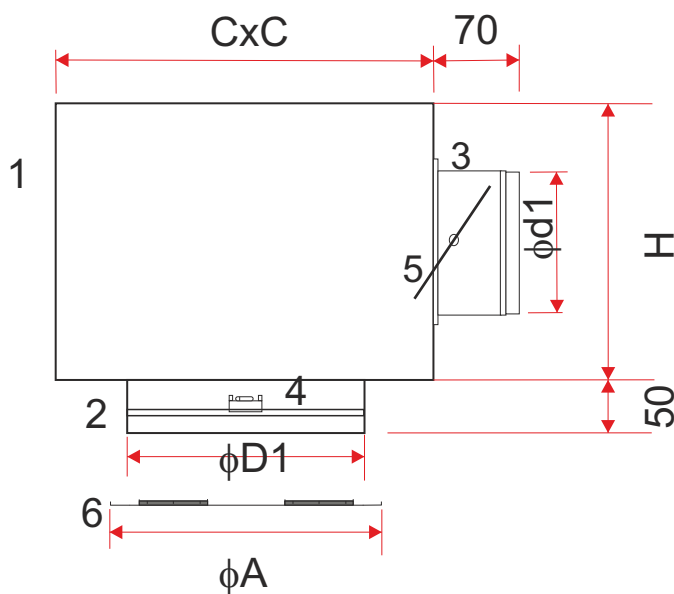

Size A	C	H	φd1	φD1
300	395	280	158	295
400	495	330	248	395
500	595	380	313	495
600	695	380	313	595
625	720	595	398	620
825	920	595	398	820

Other sizes are produced on customer request

1. Plenum box
2. Connected spigot
3. Air intake spigot
4. Crossbar
5. Adjustment damper
6. Round swirl diffuser NWO-3

Workmanship - the setting variants of blades and direction of air flow

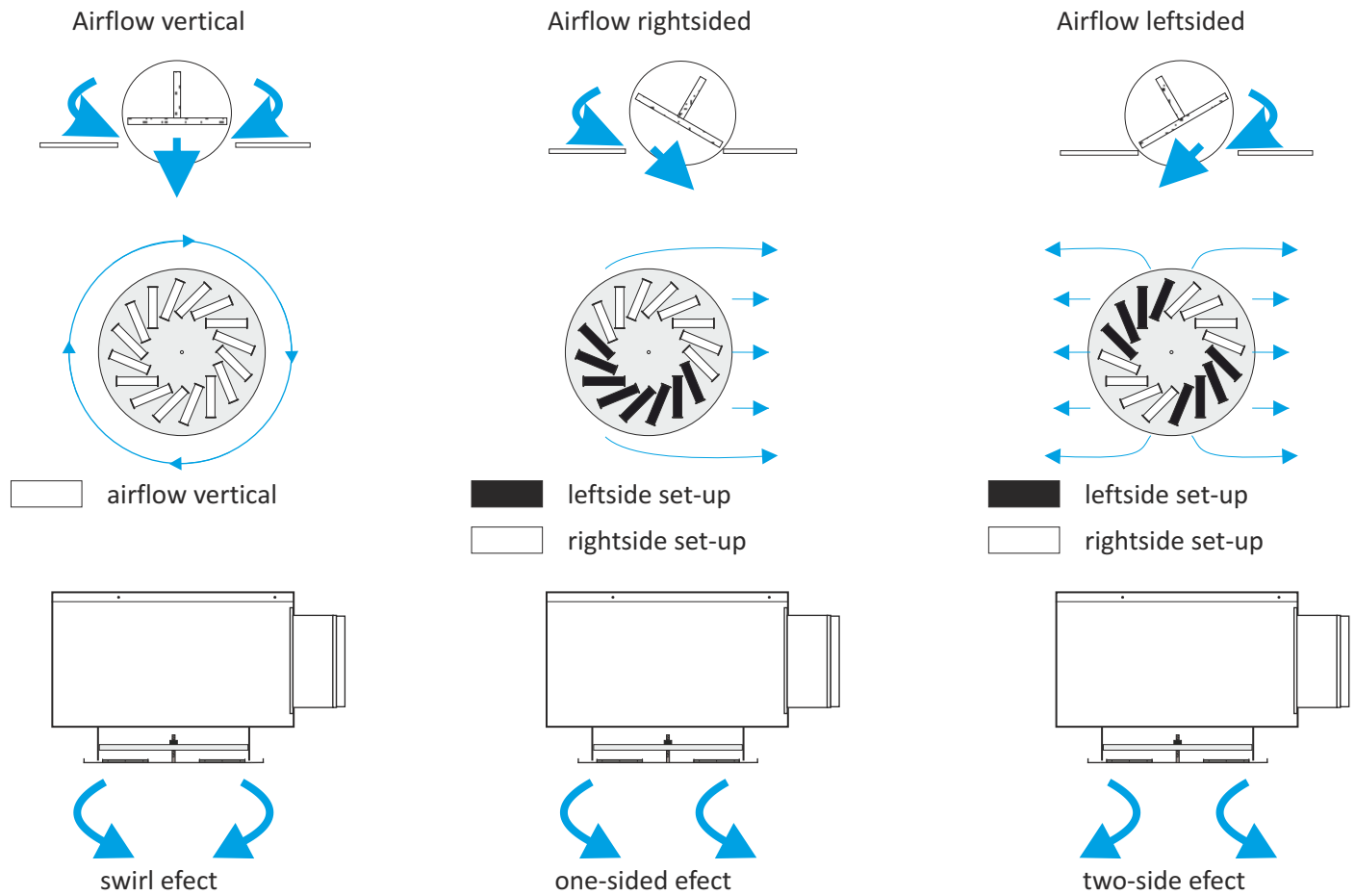

Methods of mounting

W1



Assembly visible using screws and the mounting holes in the corners of diffuser faceplate.

W2

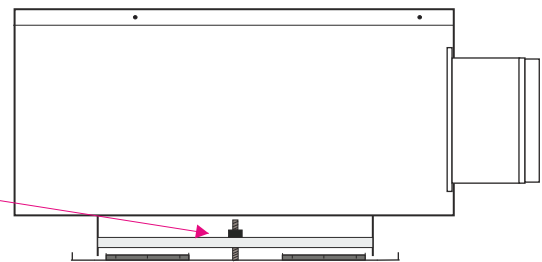

Central assembly through the crossbar (WMC) mounted in the plenum box and the central mounting screw.

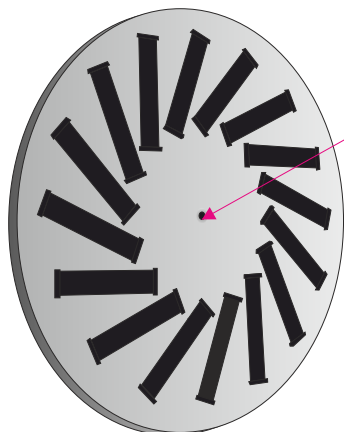

central screw

Technical data

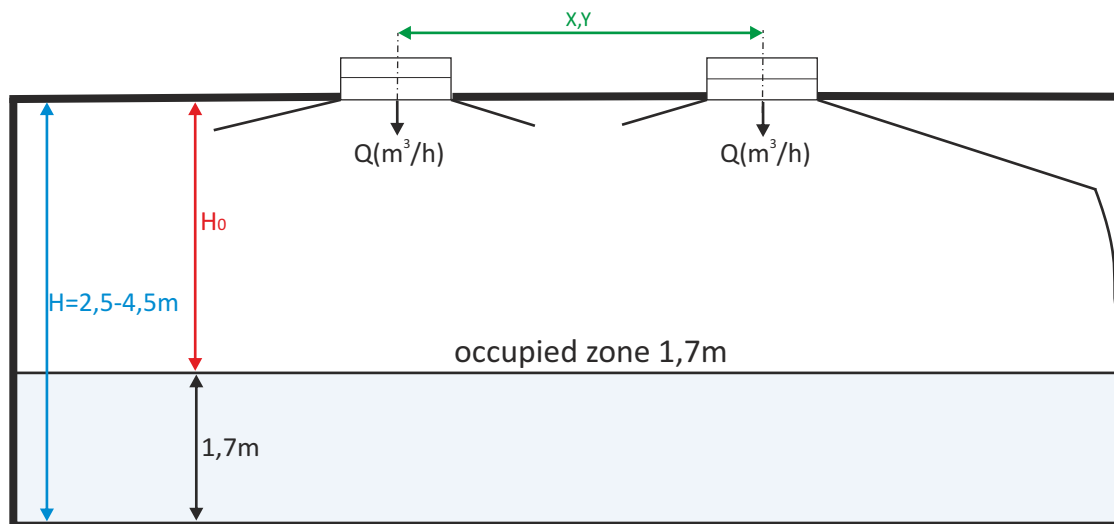

Marking:

- X** [m]-distance between the diffusers (length)
- Y** [m]-distance between the diffusers (width)
- Q** [m³/h]- air volume flow
- L_{WA}** [dB(A)]- acoustic power level
- ΔP** [Pa]- pressure drop
- H₀** [m]- height from the ceiling to the occupied zone
- V_{H0}** [m/s]- air velocity at the height of H₀

Pressure drop and acoustic power

Plenum box with spigot : top ————— side

Size : 300/8, 400/8, 500/8, 600/8

Size : 400/16, 500/16, 600/16, 625/16

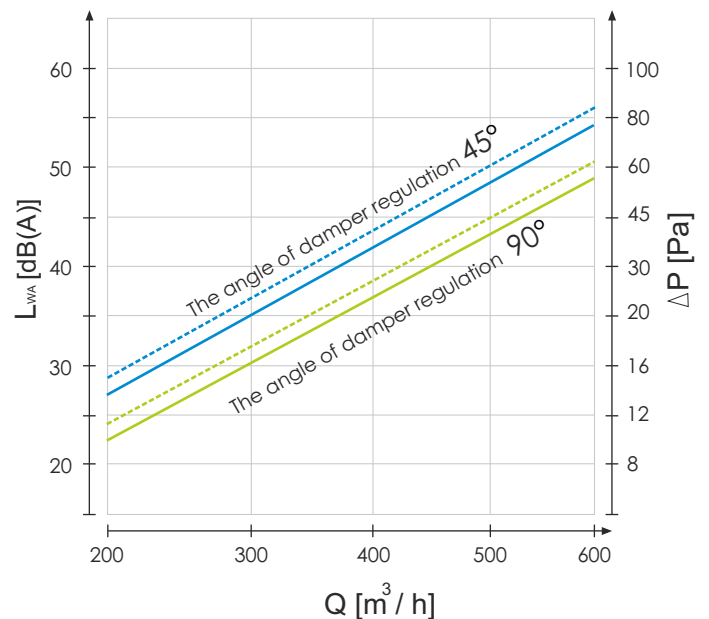
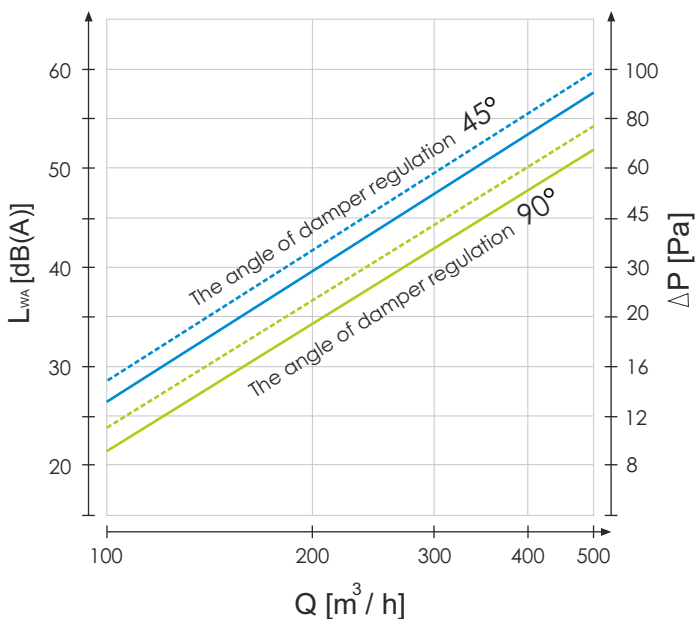

Pressure drop and acoustic power

Plenum box with spigot : top —————

side (dotted line)

Size : 500/24, 600/24, 625/24

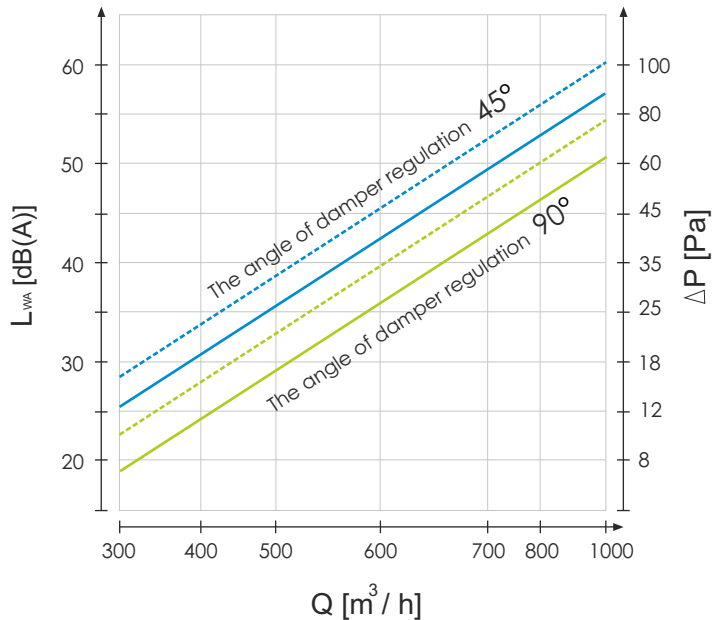

Size : 600/32, 625/32

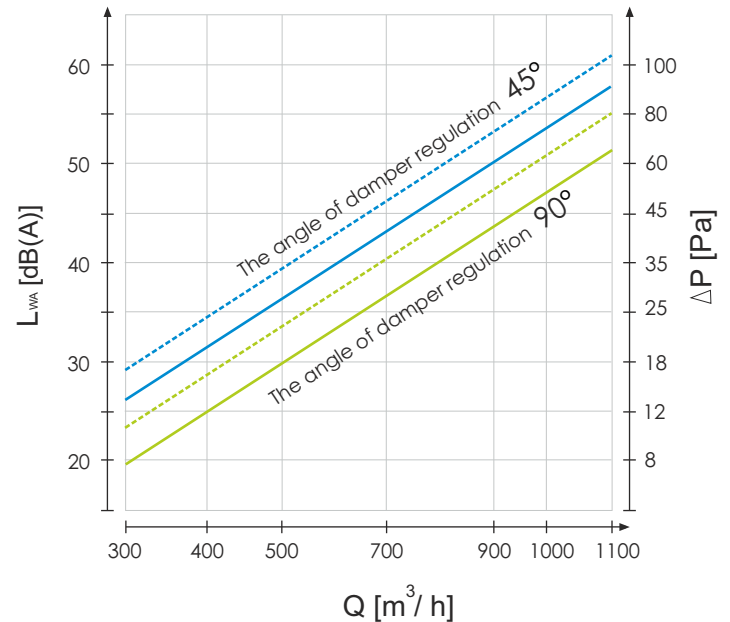

Size : 600x600/48

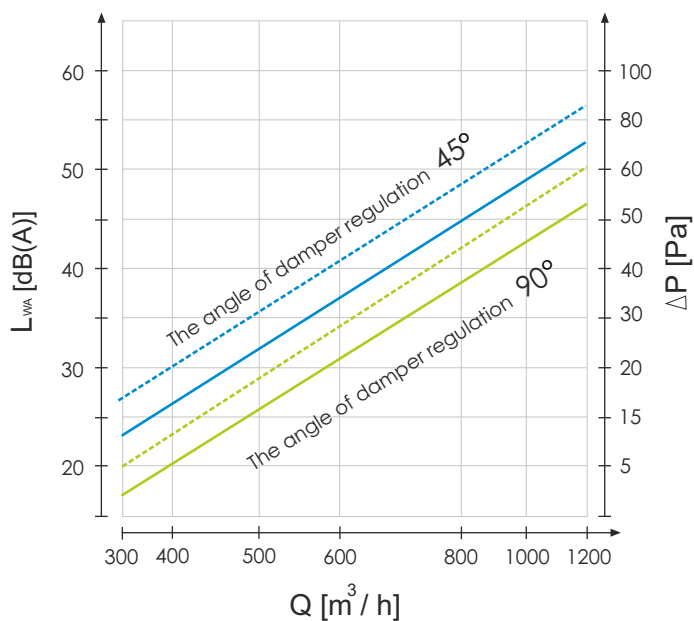

Size : 825x825/72

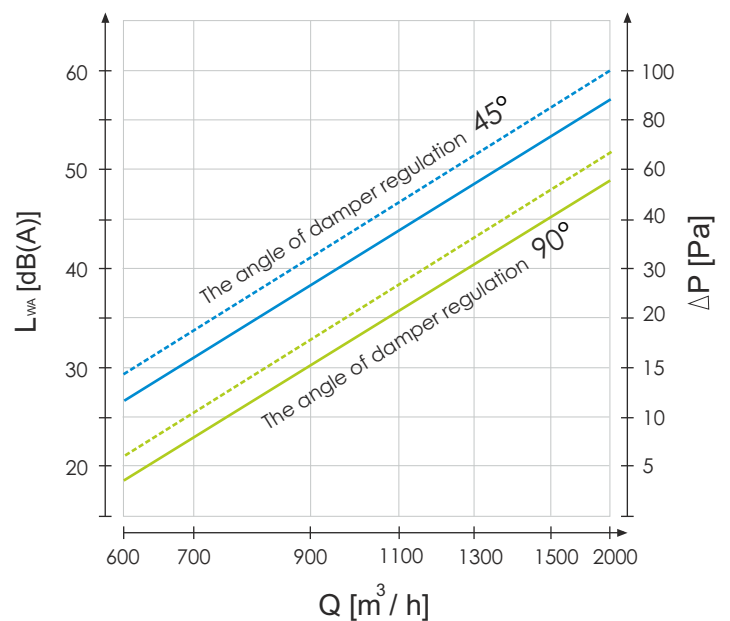

Marking:

Q [m³/h]- air volume flow

L_{wa} [dB(A)]- acoustic power level

ΔP [Pa]- pressure drop

Dependence of the air velocity from stream range

Size : 300/8, 400/8, 500/8, 600/8

Spacing between diffusers $Y=2,5$ do $3,5$ m

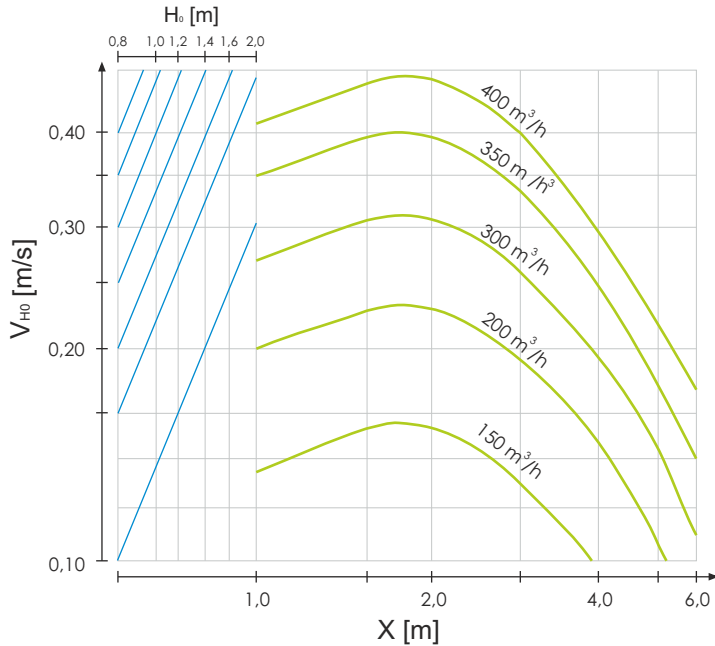

Spacing between diffusers $Y>4$ m

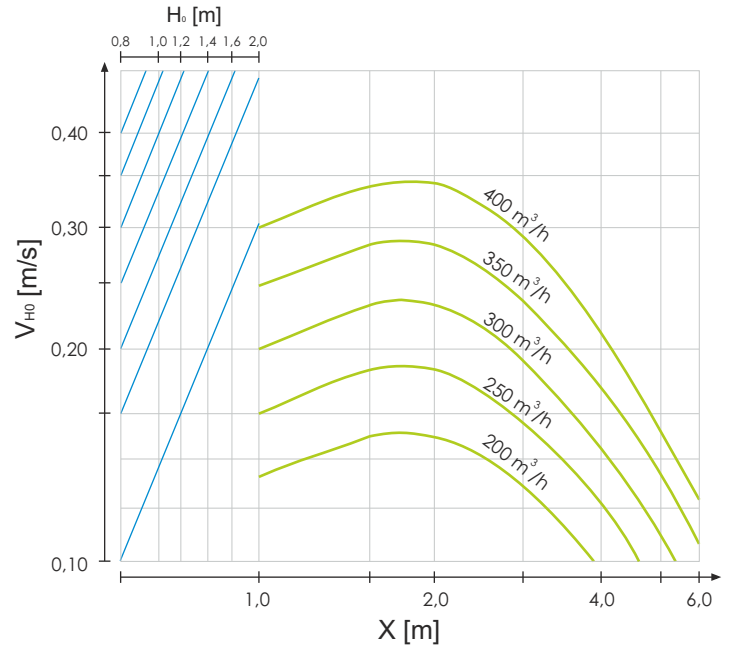

Size : 400/16, 500/16, 600/16, 625/16

Spacing between diffusers $Y=2,5$ do $3,5$ m

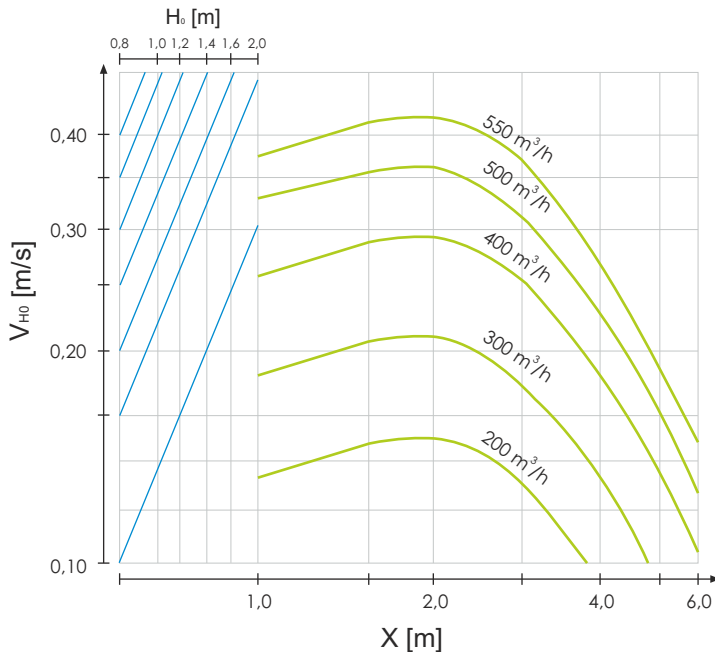

Spacing between diffusers $Y>4$ m

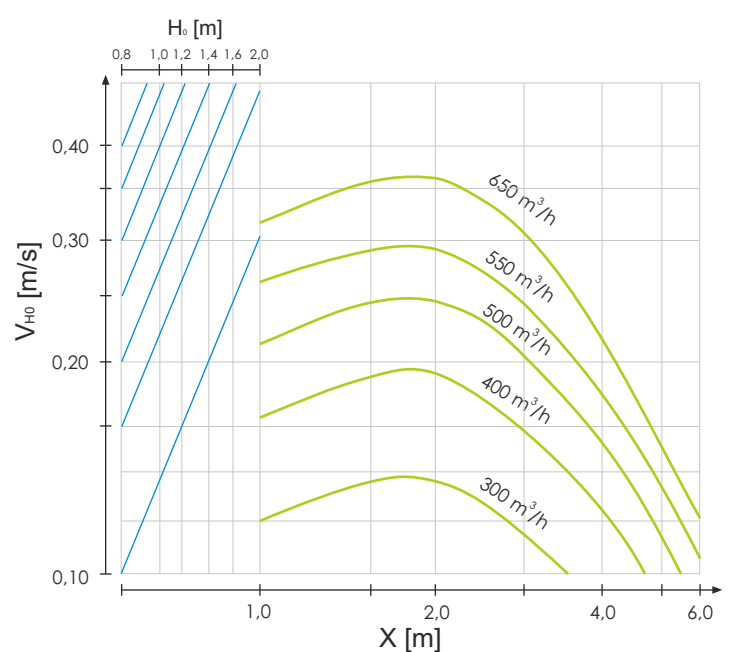

Marking:

X [m.]-distance between the diffusers (length)

Y [m.]-distance between the diffusers (width)

Q [m³/h]- air volume flow

H₀ [m.]- height from the ceiling to the occupied zone

V_{H0} [m/s]- air velocity at the height of H₀

Dependence of the air velocity from stream range

Size : 500/24, 600/24, 625/24

Spacing between diffusers $Y=2,5$ do $3,5$ m

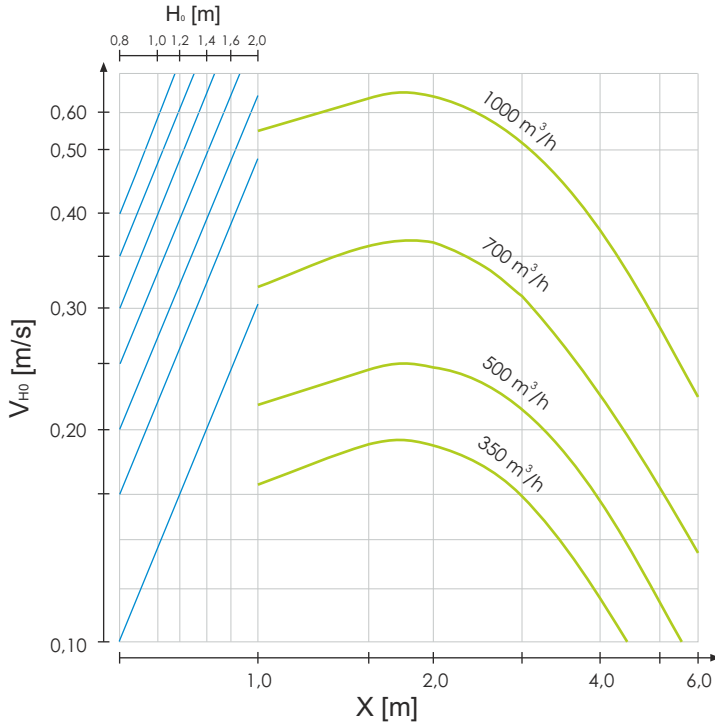

Spacing between diffusers $Y>4$ m

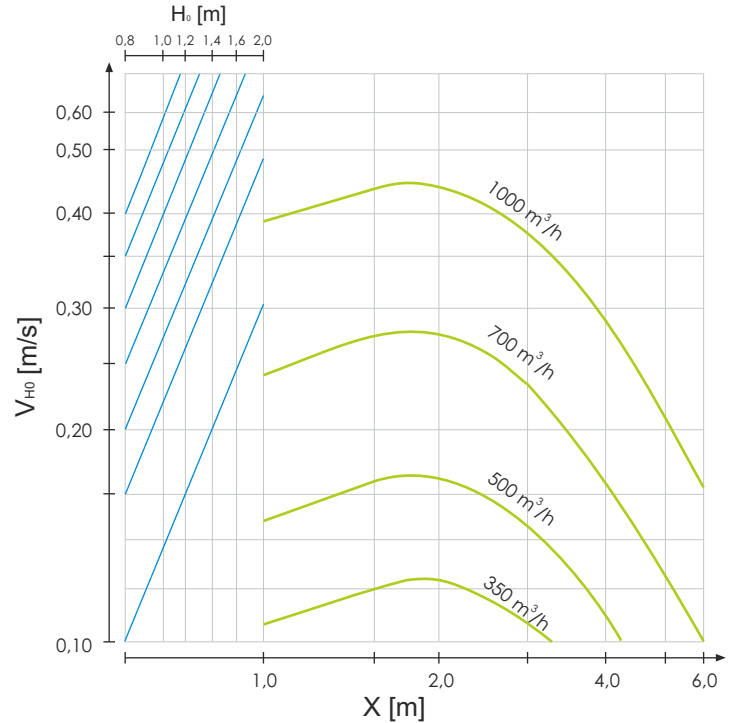

Size : 600/32, 625/32

Spacing between diffusers $Y=2,5$ do $3,5$ m

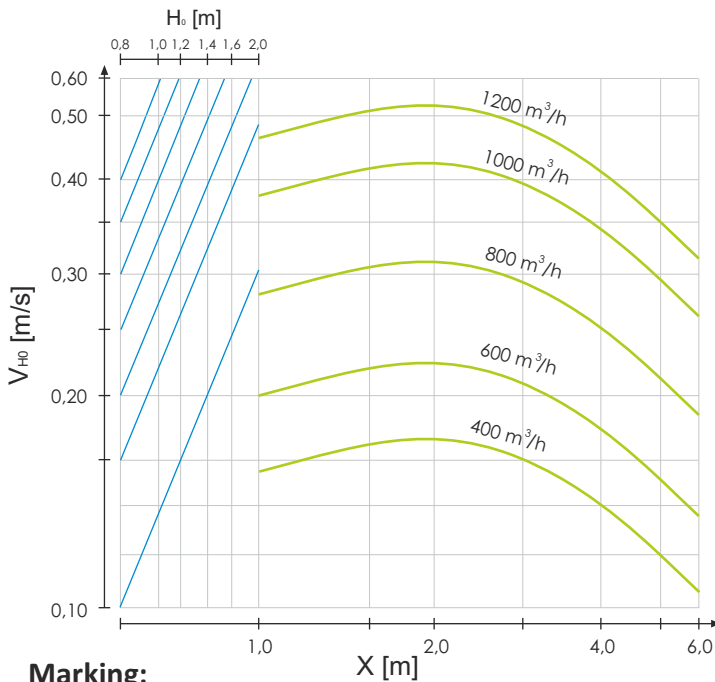

Spacing between diffusers $Y>4$ m

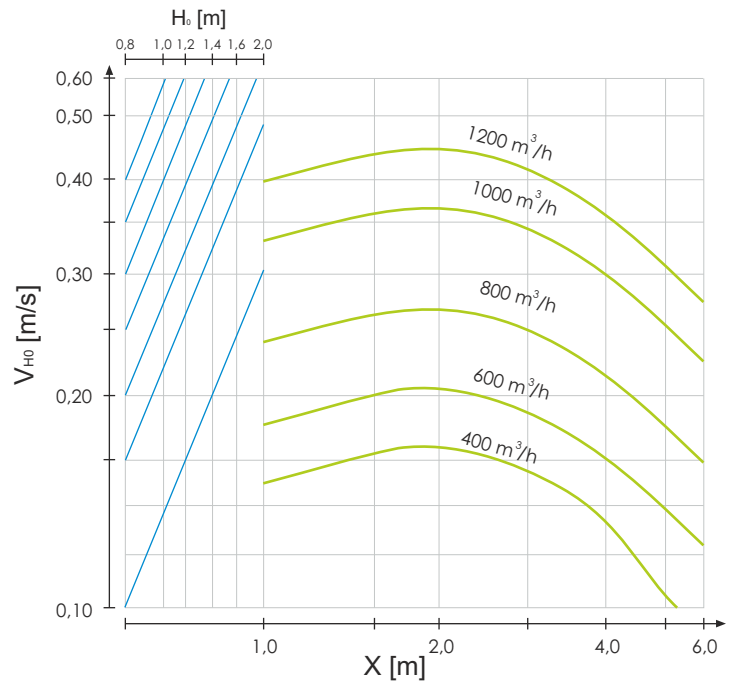

Marking:

- X [m]**-distance between the diffusers (length)
- Y [m]**-distance between the diffusers (width)
- Q [m³/h]**- air volume flow
- H₀ [m]**- height from the ceiling to the occupied zone
- V_{H0} [m/s]**- air velocity at the height of H₀

Dependence of the air velocity from stream range

Size : 600x600/48

Spacing between diffusers $Y=2,5$ do $3,5$ m

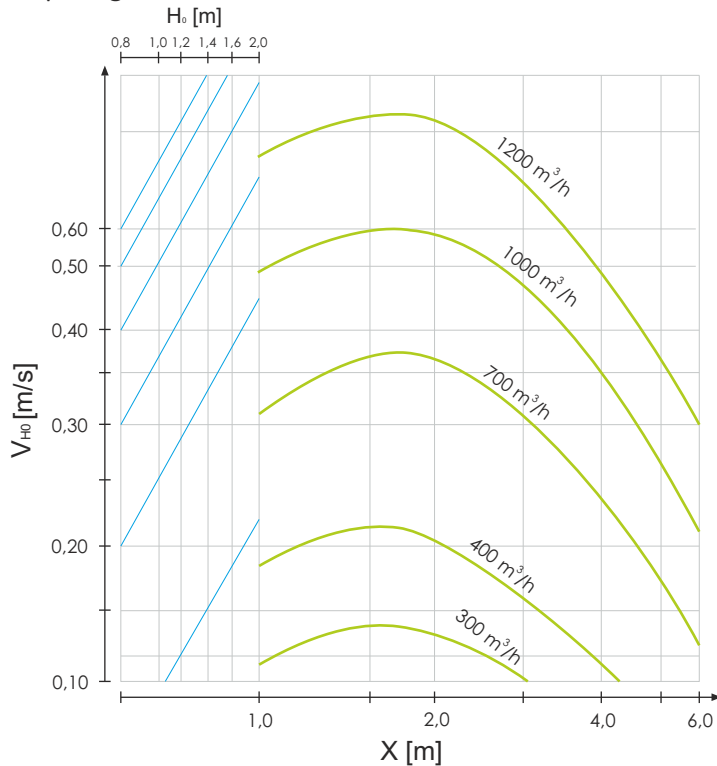

Spacing between diffusers $Y>4$ m

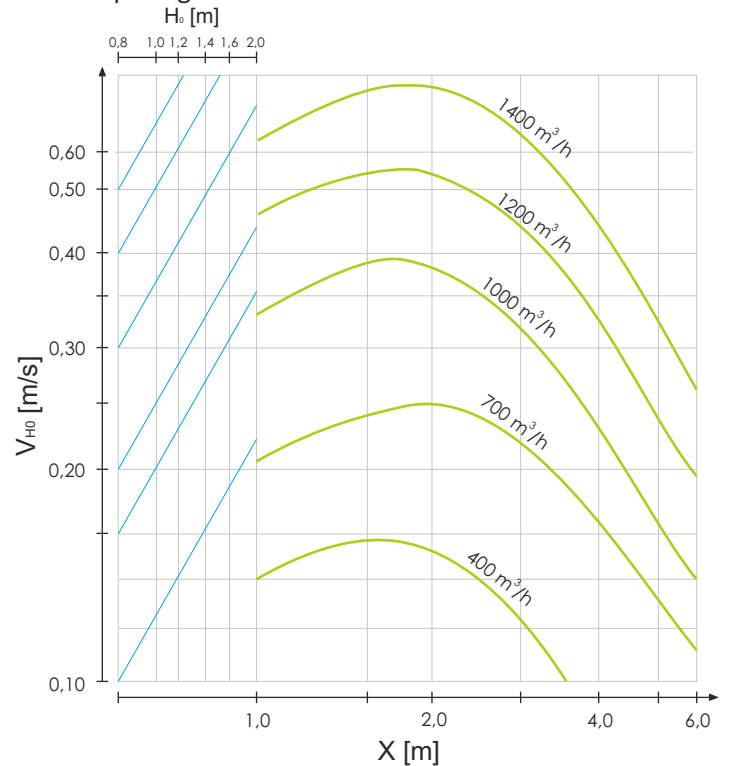

Size: 825x825/72

Spacing between diffusers $Y=2,5$ do $3,5$ m

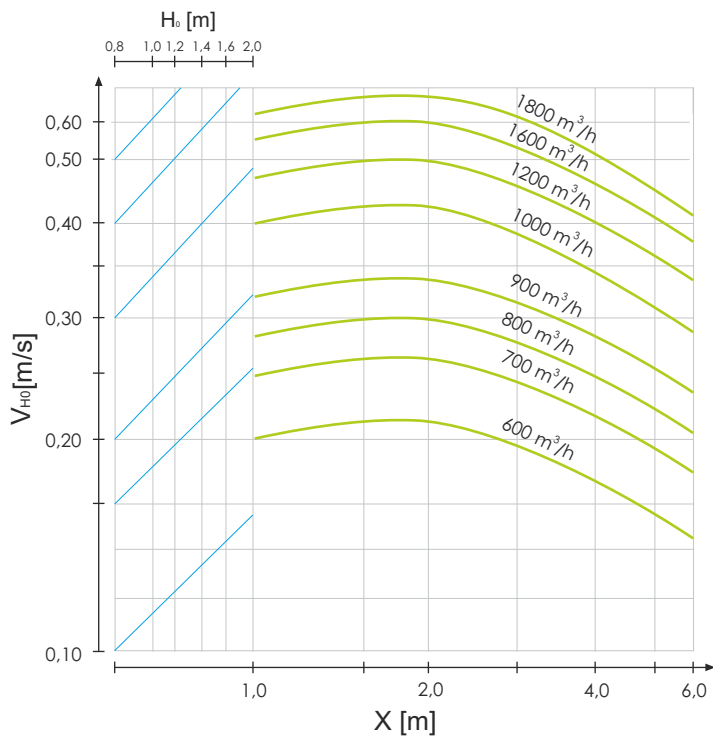

Spacing between diffusers $Y>4$ m

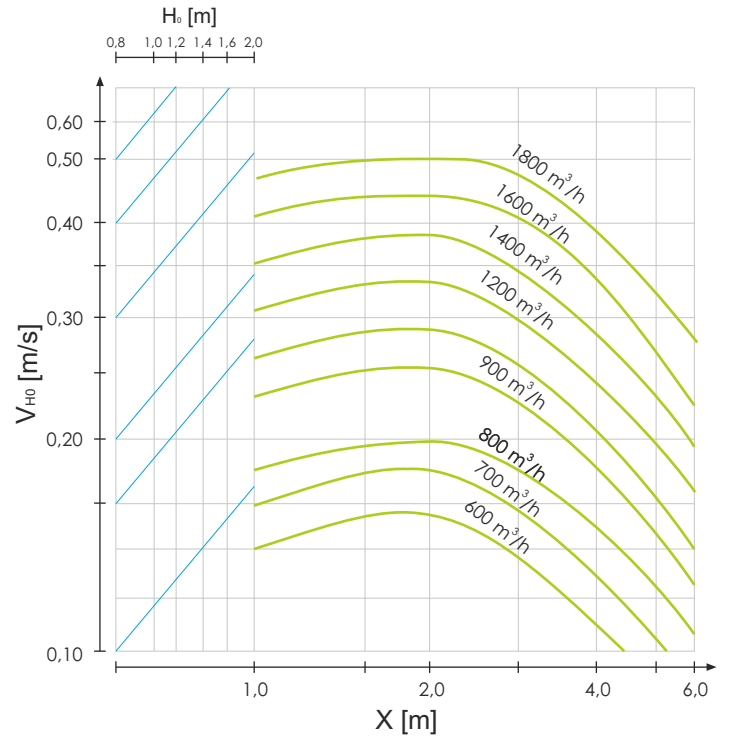

Marking:

X [m]-distance between the diffusers (length)

Y [m]-distance between the diffusers (width)

Q [m³/h]- air volume flow

H₀ [m]- height from the ceiling to the occupied zone

V_{H0} [m/s]- air velocity at the height of H₀

EXAMPLE

EXAMPLE

- plate 600x600
- diffuser efficiency $Q=700 \text{ m}^3/\text{h}$

Reading from a graph:

Appropriate diffusers 32 and 48 blades
(72 blades only in plates 825x825)

- selected diffuser NWK-3 (48 blades)

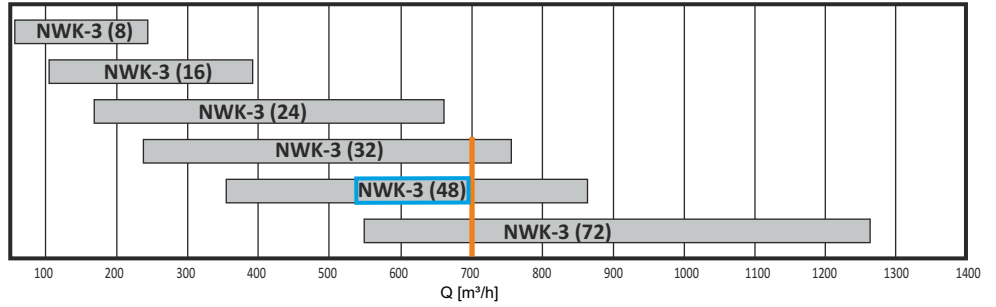

EXAMPLE

- plenum box with top spigot
- damper - full opening (90°)
- diffuser efficiency $Q=700 \text{ m}^3/\text{h}$

Reading from the graph:

- acoustic power $L_{WA} = 35 \text{ dB}$
- pressure drop $\Delta p = 30 \text{ Pa}$

Size : 600x600/48

Plenum box with spigot: top ———
side - - - - -

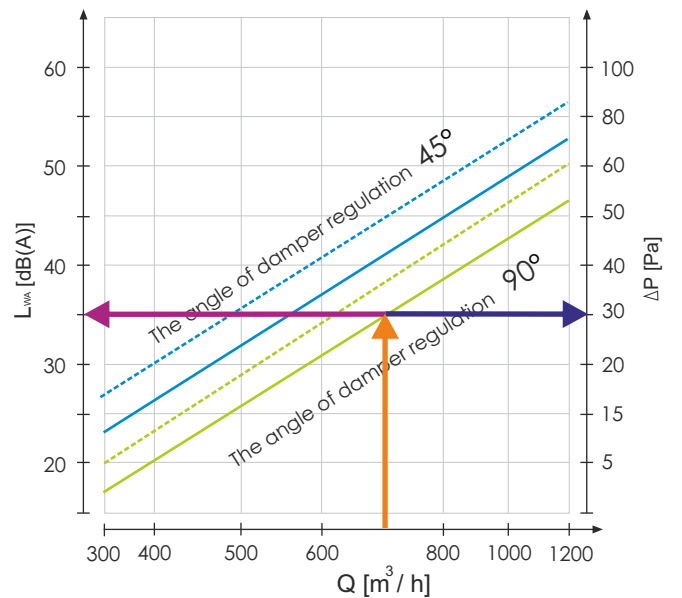

Size : 600x600/48

Spacing between diffusers $Y=2,5$ do $3,5 \text{ m}$

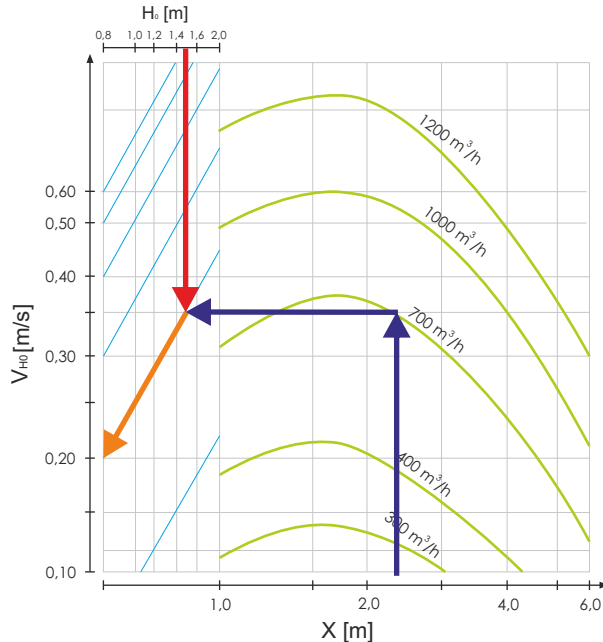

EXAMPLE

- Spacing between diffusers $Y= 3,5 \text{ m}$
- Spacing between diffusers $X= 2,4 \text{ m}$
- room height $H= 3,2 \text{ m}$
- height from the ceiling to the occupied zone $H_0= H-1,7 \text{ m}= 3,2 \text{ m}- 1,7 \text{ m}= 1,5 \text{ m}$

Reading from the graph:

- air velocity $V_{H_0}= 0,20 \text{ m/s}$

The method of placing an order

Please make orders according to the following formula:

NWO-3 / 'N' / 'L' / 'P' / 'RAL' / 'M' / 'W' + 'SR' / 'I' / 'P' / 'K' / 'H'

'N'	the size of the diffuser: 300, 400, 500, 600, 625, 800, 825
'L'	quantity of blades 8, 16, 24, 32, 48, 54, 72
'P'	purpose of the diffuser: Nc - supply air (diffuser equipped with black blades)* Nb - supply air (diffuser equipped with white blades) W - extract air (diffuser without blades)
'RAL'	diffuser color according to RAL palette(standard RAL9016*)
'M'	material: ST - powder coated steel* AL - aluminum powder coated KO - stainless steel / acid proof steel (type 1.4301 or 1.4404)
'W'	mounting option: W1 - visible assembly with screws W2 - the central assembly using the crossbar (in plenum box)
	plenum box:
'SR-2'	SR-Gc - plenum box with top spigot connection SR-Bc - plenum box with side spigot connection
'I'	isolation: none - plenum box without isolation* Iz - outside isolation (thermal) Iw - inside isolation (acoustic)
'P'	adjustment damper at spigot connection: none - no damper* P - damper on spigot connection adjustable from the outside PP - damper on spigot connection adjustable from the inside
'K'	diameter spigot connection in size mm
'H'	the height of the plenum box in mm*

* - If you don't give the information will be used standard parameters.